

MMg

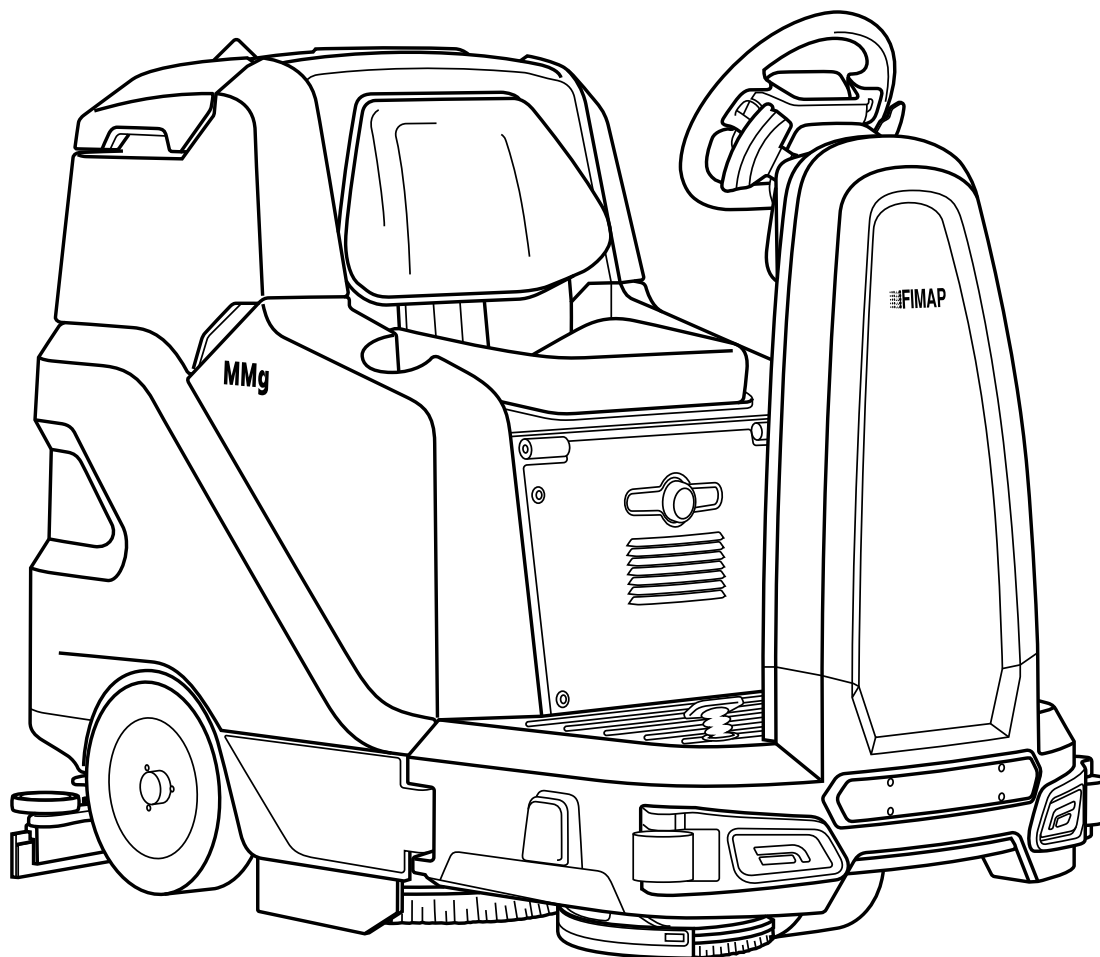

PROFESSIONAL SCRUBBING MACHINES

*USE AND MAINTENANCE MANUAL*

 **FIMAP**<sup>®</sup>





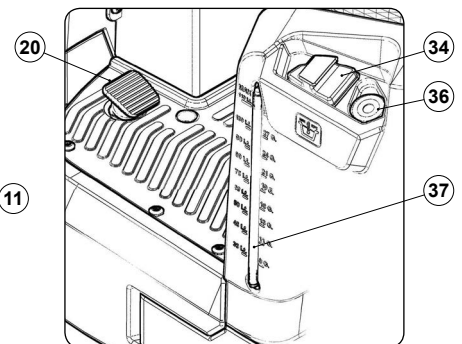
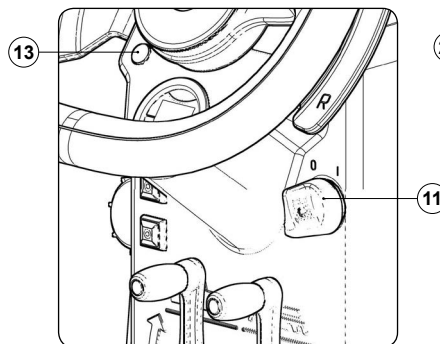
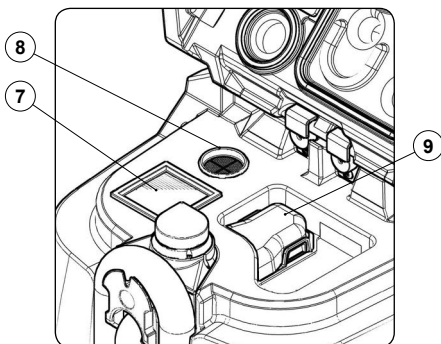
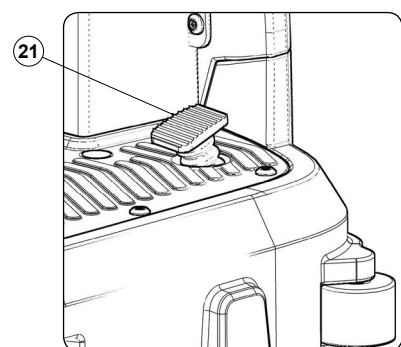
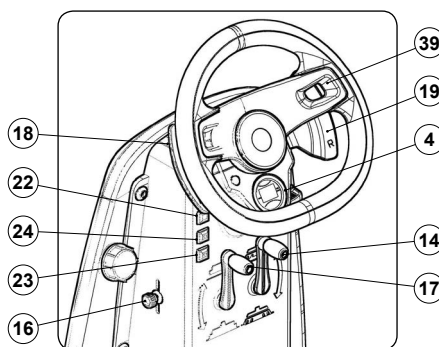
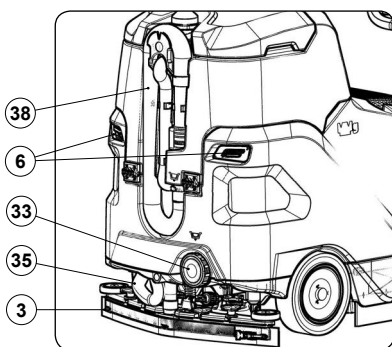
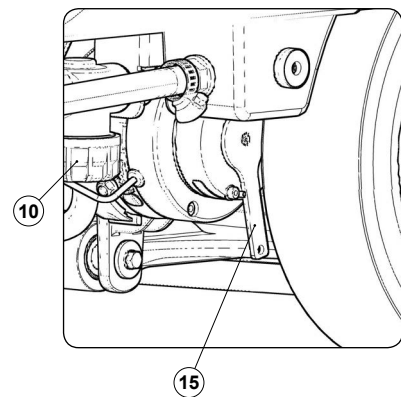
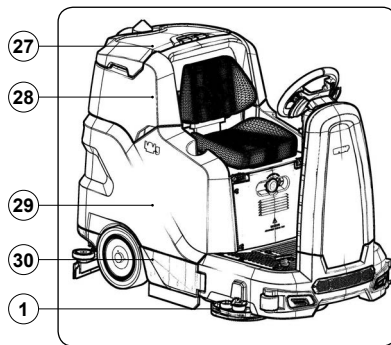

### MAIN MACHINE COMPONENTS

The machine's main components are the following:

- |  |   |
|--|---|
| <ol style="list-style-type: none"> <li>1. Lateral scrubbing brush head (optional).</li> <li>2. Scrubbing brush head.</li> <li>3. Squeegee body.</li> <li>4. Hour meter display – battery charge level.</li> <li>5. Headlights (optional).</li> <li>6. Tail lights (optional).</li> <li>7. Vacuum motor air intake filter.</li> <li>8. Vacuum motor air duct filter.</li> <li>9. Recovery tank filter.</li> <li>10. Detergent solution filter.</li> <li>11. Main key switch.</li> <li>12. Blinking light (optional).</li> <li>13. Brush head extra pressure LED indicator.</li> <li>14. Brush head control lever.</li> <li>15. Electric brake control lever.</li> <li>16. Detergent solution tap control lever.</li> <li>17. Squeegee control lever.</li> <li>18. Brush head extra pressure selection lever.</li> <li>19. Reverse gear selection lever.</li> <li>20. Service brake pedal.</li> <li>21. Drive pedal.</li> <li>22. Horn button.</li> <li>23. Recycle control button (optional).</li> <li>24. Lateral brush control button (optional).</li> <li>25. Emergency button.</li> </ol> | <ol style="list-style-type: none"> <li>26. Operator seat.</li> <li>27. Recovery tank lid.</li> <li>28. Recovery tank.</li> <li>29. Solution tank.</li> <li>30. Right hatch.</li> <li>31. Left hatch.</li> <li>32. Squeegee support.</li> <li>33. Solution tank drainage shaft cap.</li> <li>34. Solution tank cap.</li> <li>35. Squeegee vacuum hose.</li> <li>36. Solution tank rapid filling hose.</li> <li>37. Solution tank level hose.</li> <li>38. Recovery tank drainage hose.</li> <li>39. Steering wheel.</li> </ol> |
|--|---|







**CONTENTS**

<b>MAIN MACHINE COMPONENTS</b> .....	<b>3</b>	10. CLEANING THE DEBRIS HOPPER (SWEEPING VERSION) ....	19
<b>CONTENTS</b> .....	<b>4</b>	11. EMPTYING THE SOLUTION TANK.....	20
<b>1. GENERAL SAFETY REGULATIONS</b> .....	<b>5</b>	12. CLEANING THE WATER SYSTEM FILTER .....	20
<b>2. SYMBOLS USED IN THE MANUAL</b> .....	<b>9</b>	13. CLEANING THE VACUUM TUBE.....	20
<b>3. PURPOSE AND CONTENT OF THE MANUAL</b> .....	<b>9</b>	<b>21. EXTRAORDINARY MAINTENANCE WORK</b> .....	<b>21</b>
<b>4. TARGET GROUP</b> .....	<b>9</b>	1. ASSEMBLING THE BRUSH HEAD BRUSHES	
<b>5. STORING THE USE AND MAINTENANCE MANUAL</b> .....	<b>9</b>	(SCRUBBING VERSION) .....	21
<b>6. ON CONSIGNMENT OF THE MACHINE</b> .....	<b>9</b>	2. ASSEMBLING LATERAL BRUSH 1SL	
<b>7. INTRODUCTORY COMMENT</b> .....	<b>9</b>	(SCRUBBING VERSION) .....	21
<b>8. IDENTIFICATION DATA</b> .....	<b>9</b>	3. ASSEMBLING THE BRUSH HEAD BRUSHES	
<b>9. TECHNICAL DESCRIPTION</b> .....	<b>9</b>	(SWEEPING VERSION) .....	21
<b>10. INTENDED USE</b> .....	<b>9</b>	4. ASSEMBLING THE ABRASIVE PAD (ORBITAL VERSION) ....	21
<b>11. SAFETY</b> .....	<b>9</b>	5. REPLACING THE BRUSH HEAD BRUSHES	
<b>12. SERIAL NUMBER PLATE</b> .....	<b>9</b>	(SCRUBBING VERSION) .....	21
<b>13. TECHNICAL DATA</b> .....	<b>10</b>	6. REPLACING THE BRUSH HEAD BRUSHES	
<b>14. SYMBOLS USED ON THE MACHINE</b> .....	<b>11</b>	(SWEEPING VERSION) .....	22
<b>15. SYMBOLS USED ON THE SERIAL NUMBER</b>		7. REPLACING LATERAL BRUSH 1SL	
<b>PLATE</b> .....	<b>11</b>	(SCRUBBING VERSION) .....	22
<b>16. MACHINE PREPARATION</b> .....	<b>12</b>	8. REPLACING THE LATERAL BRUSH	
1. HANDLING THE PACKAGED MACHINE .....	12	(SWEEPING VERSION) .....	22
2. HOW TO UNPACK THE MACHINE .....	12	9. REPLACING THE ABRASIVE PAD .....	22
3. HOW TO MOVE THE MACHINE .....	12	10. REPLACING THE SQUEEGEE UNIT RUBBER BLADES.....	22
4. SECURING THE MACHINE .....	13	<b>22. DISPOSAL</b> .....	<b>22</b>
5. TYPE OF BATTERY TO BE USED .....	13	<b>23. ADJUSTMENT INTERVENTIONS</b> .....	<b>23</b>
6. BATTERY MAINTENANCE AND DISPOSAL.....	13	ADJUSTING THE SQUEEGEE BODY'S	
7. INSERTING THE BATTERIES INTO THE MACHINE.....	13	RUBBER BLADES .....	23
8. CONNECTING BATTERIES TO THE SYSTEM		<b>24. EC DECLARATION OF CONFORMITY</b> .....	<b>23</b>
OF THE APPLIANCE .....	13	<b>25. TROUBLESHOOTING</b> .....	<b>24</b>
9. RECHARGING THE BATTERIES .....	13		
10. ASSEMBLING THE SQUEEGEE.....	14		
11. FILLING THE SOLUTION TANK .....	14		
12. DETERGENT SOLUTION.....	14		
<b>17. PREPARING TO WORK</b> .....	<b>14</b>		
<b>18. WORK</b> .....	<b>14</b>		
1. SCRUBBING WITH DRYING .....	14		
2. SCRUBBING WITHOUT DRYING .....	15		
3. DRYING.....	15		
4. REGULATING THE DETERGENT SOLUTION.....	15		
5. REVERSE GEAR .....	16		
6. EXTRA BRUSH HEAD PRESSURE .....	16		
7. ACOUSTIC SIGNALLING DEVICE.....	16		
8. WORKING HEADLIGHTS (OPTIONAL) .....	16		
9. EMERGENCY BUTTON.....	16		
10. HOUR METER .....	16		
11. BATTERY CHARGE LEVEL INDICATOR.....	16		
12. LATERAL BRUSH 1SL (SCRUBBING VERSION).....	16		
13. LATERAL BRUSH 2SL (SWEEPING VERSION).....	17		
14. DETERGENT SOLUTION RECYCLING (FLR VERSION) .....	17		
15. OVERFLOW DEVICE .....	17		
<b>19. AT THE END OF THE WORK</b> .....	<b>17</b>		
<b>20. RECOMMENDED MAINTENANCE OPERATIONS</b> .....	<b>17</b>		
1. EMPTYING THE RECOVERY TANK .....	18		
2. EMPTYING THE DEBRIS HOPPER (SWEEPING VERSION)...	18		
3. CLEANING THE SQUEEGEE BODY.....	18		
4. CLEANING THE BRUSH HEAD BRUSHES			
(SCRUBBING VERSION) .....	18		
5. CLEANING THE BRUSH HEAD BRUSHES			
(SWEEPING VERSION) .....	18		
6. CLEANING THE LATERAL BRUSH (SCRUBBING VERSION) ..	19		
7. CLEANING THE LATERAL BRUSH (SWEEPING VERSION) ...	19		
8. CLEANING THE RECOVERY TANK FILTERS .....	19		
9. CLEANING THE RECOVERY TANK.....	19		

## 1. GENERAL SAFETY REGULATIONS

The following symbols are used to indicate any potentially hazardous situations. Always read this information carefully and take the necessary precautions to protect any people and/or objects that may be present.

Operator cooperation is paramount for accident prevention. No accident prevention programme can be effective without the full cooperation of the person directly responsible for the machine's operation. Most accidents that occur at the workplace, during work activities, or while in transit, are caused by the failure to respect the most basic safety regulations. An attentive, careful operator is most effective guarantee against accidents and is fundamental in order to implement any prevention programme.

-  **DANGER:** Indicates an imminent danger that could cause serious injury or death.
-  **WARNING:** Indicates a probable dangerous situation that could cause serious injury or death.
-  **CAUTION:** Indicates a probable dangerous situation that could cause minor injuries.
-  **ATTENTION:** Indicates a probable dangerous situation that could damage objects.
-  **NOTE:** Indicates a note regarding essential or useful functions.
-  **CONSULTATION:** Indicates the need to consult the Operator's Manual before performing any operation.

### **DANGER:**

- If you encounter a damaged cable used for recharging the batteries, immediately contact an authorised service centre.
- In the event of danger, take prompt action by pressing the emergency button near the operator's seat.
- The socket for the battery charger cable must have a prescribed earth connection.
- Never collect gases, explosive/inflammable liquids or powders, nor acids and solvents! These include gasoline, paint thinners and fuel oil (which, when mixed with the vacuum air, can form explosive vapours or mixtures), and also non-diluted acids and solvents, acetones, aluminium and magnesium powders. These substances may also corrode the materials used to construct the machine.
- If the machine is used in dangerous areas (e.g. petrol stations), the relative safety standards must be observed. It is forbidden to use the machine in environments with a potentially explosive atmosphere.
- Keep sparks, flames, and incandescent materials at a safe distance from the batteries. Explosive gases are emitted during normal use.
- In order to avoid short-circuits when working in the vicinity of electrical components, do the following: avoid the use of non-insulated tools; do not place or allow metallic objects to fall upon the electrically powered components; remove any rings, watches and/or clothing with metallic parts that might come into contact with the electrically powered components.
- do not work underneath the raised machine without adequate fixed safety supports.
- highly explosive hydrogen gas is generated while charging the batteries. Keep the tank unit open during the entire battery recharging cycle, and only perform the procedure in well-ventilated areas at a safe distance from any open flames.

**WARNING:**

- Read all the relevant instructions carefully before performing any maintenance/repair operations.
- Before using the battery charger, make sure that the frequency and the voltage values indicated on the machine's data plate coincide with the network's values.
- Keep the battery charger's cable at a safe distance from any hot surfaces.
- The machine must be exclusively used by authorised, trained personnel.
- Do not use the machine on surfaces with a slope greater than the one indicated on the serial number plate.
- The machine is not suitable for cleaning rough or uneven floors. Do not use the machine on slopes.
- In the event of a fire, use a powder extinguisher. Do not use water.
- Adapt the speed to the adhesion conditions.
- If the machine does not work properly, check this is not caused by failure to carry out routine maintenance. Otherwise, ask for intervention of the authorised technical assistance centre.
- Restore all electrical connections after any maintenance interventions.
- Never smoke in the machine's vicinity while the batteries are charging.
- Remove the starter key from the ignition in order to prevent any unauthorized use of the machine itself.
- Always protect the machine against sunlight, rain, and other atmospheric agents, both while it is stationary and while it is in function. Store the machine in a dry, sheltered place: this machine is only designed for use under dry conditions, and must not be used or stored outdoors under humid conditions.

**CAUTION:**

- When doing maintenance work, switch off the machine using the main switch. Remove the key from the instrument panel and remove the battery connector from the electrical system connector.
- In order to prevent the unauthorised use of the machine, the power supply must be disconnected: switch the machine off using the main switch (by removing the key from the block) and disconnect the battery's connector from the electrical system's connector.
- Children must be supervised to ensure they do not play with the machine.
- During the working of the machine, pay attention to other people and especially to children.
- The machine must only be powered with a voltage equal to that shown on the serial number plate.
- If the machine is left unattended, it must be protected from any accidental movements.
- Read the labels on the machine carefully. Do not cover them for any reason, and replace them immediately if they become damaged.
- The machine must only be used and stored in an enclosed or covered environment.
- The machine must not be used or stored outdoors in damp conditions or directly exposed to rain.
- The machine does not cause harmful vibrations.

**ATTENTION:**

- If the machine is to be used in the presence of other individuals, aside from the operator, the beacon light (optional) must be utilized.
- Always take appropriate measures to protect any individuals and/or objects that may be



- present while using this machine.
- Be careful to avoid collisions with shelving or scaffolding, above all if there is a risk of objects falling from heights.
  - Do not place any liquid containers on the machine.
  - The machine must only be used under temperature conditions ranging from 0 °C to +40 °C.
  - The machine must only be stored under temperature conditions ranging from 0 °C to +40 °C.
  - The humidity level must be between 30% and 95%.
  - When using detergents to clean the flooring, always follow the instructions and respect the warnings indicated on the containers' labels.
  - Always use appropriate gloves and protective equipment when handling the detergents used to clean the floor.
  - Do not use the machine as a means of transport.
  - Avoid working with the brushes when the machine is standing still, so as not to damage the floor.
  - In the event of a fire, use a powder fire extinguisher if possible, and avoid the use of water.
  - Never tamper with the machine's protection devices for any reason; always follow the supplied routine maintenance instructions scrupulously.
  - Do not allow any objects to penetrate into the machine's openings. Do not use the machine if the openings are obstructed.
  - Keep the machine's openings free of any dust, lint, hairs, or any other foreign materials that could reduce the airflow.
  - Do not remove or alter any labels affixed to the machine.
  - The electro-magnetic brake must be released in order to move the machine manually. Once the manual movement operations have been completed, the electro-magnetic brake must be re-engaged. Never use the machine with the electro-magnetic brake disengaged.
  - If the machine needs to be pushed for maintenance purposes (batteries absent; discharged batteries; etc.), never exceed the speed of 4 km/h.
  - This machine has not been approved for use on public streets or roadways.
  - Use caution when moving the machine under temperatures below freezing. The water contained in the water recovery tank or in the pipes could freeze, and could seriously damage the machine itself.
  - Only use the brushes and pad holders that have been supplied along with the machine or those specified in the Operator's Manual. The use of other brushes or felt pads could compromise the machine's safety conditions.
  - If any issues are encountered while using the machine, check to make sure that these are not due to a lack of proper maintenance. Otherwise, request the intervention of authorized personnel or an Authorized service centre.
  - If any parts need to be replaced, always request ORIGINAL spare parts from an authorized Dealer or Retailer.
  - In order to ensure the machine's safety and proper functionality, always have the scheduled maintenance interventions (specified in the appropriate section of this Manual) performed by authorized personnel or by an authorized Service Centre.
  - Do not clean the machine with direct or pressurized jets of water, or with corrosive substances.
  - If lead batteries (WET) have been installed on the machine, avoid tilting the machine beyond 30° with respect to the horizontal plane, as this could cause the highly corrosive liquid to leak out of the batteries.
  - Remove the batteries if the machine needs to be tilted in order to perform maintenance procedures.
  - Have the machine checked by an authorised technical assistance centre every year.

- When disposing of consumable materials, observe the laws and regulations in force. Once the machine has reached the end of its service life, the materials contained within it must be disposed of in an appropriate manner, keeping in mind that the machine itself has been built using fully recyclable materials.



The descriptions contained in this document are not binding. The company therefore reserves the right to make any modifications at any time to elements, details, or accessory supply, as considered necessary for reasons of improvement or manufacturing/commercial requirements. The reproduction, even partial, of the text and drawings contained in this document is prohibited by law.

The company reserves the right to make any technical and/or supply modifications. The images are shown as reference only and are not binding as to the actual design and/or equipment.

## 2. SYMBOLS USED IN THE MANUAL



**Open book symbol with an "i":**  
Indicates the need to consult the instruction manual.



**Open book symbol:**  
Tells the operator to read the manual before using the appliance.



**Covered place symbol:**  
The operations preceded by this symbol must always be carried out in a dry, covered area.



**Information symbol:**  
Indicates additional information for the operator, to improve the use of the device.



**Warning symbol:**  
Carefully read the sections preceded by this symbol meticulously following the instructions indicated for the safety of the operator and the device.



**Danger symbol (corrosive substances):**  
The operator should always wear protective gloves to avoid the risk of serious injury to the hands caused by corrosive substances.



**Danger symbol (battery acid leakage):**  
Indicates the danger of leaking acid or acid fumes from the batteries while they are being recharged.



**Danger symbol (moving carriages):**  
Indicates that the packed product should be handled with suitable carriages that conform to legal requirements.



**Mandatory room ventilation symbol:**  
Informs the operator that the room must be ventilated while the batteries are being recharged.



**Symbol indicating the compulsory use of protective gloves:**  
Indicates that the operator should always wear protective gloves, to avoid the risk of serious injury to his hands from sharp objects.



**Symbol indicating a treading ban:**  
Informs the operator that it is forbidden to tread on machine components, as this could lead to serious injury.



**Recycling symbol:**  
Tells the operator to carry out the operations in compliance with environmental regulations in force in the place where the appliance is being used.



**Disposal symbol:**  
Carefully read the sections marked with this symbol for disposing of the appliance.

## 3. PURPOSE AND CONTENT OF THE MANUAL

The aim of this manual is to provide customers with all the information needed to use the machine in the safest, most appropriate and most autonomous way. This includes information concerning technical aspects, safety, operation, downtime, maintenance, spare parts and scrapping. The operators and qualified technicians must carefully read the instructions in this manual before carrying out any operations on the machine. If in doubt about the correct interpretation of instructions, contact your nearest Customer Service Centre to obtain the necessary clarifications.

## 4. TARGET GROUP

This manual is written both for operators and for qualified machine maintenance technicians. Operators must not perform operations that should be carried out by qualified technicians. The manufacturer is not liable for damages resulting from failure to comply with this veto.

## 5. STORING THE USE AND MAINTENANCE MANUAL

The Use and Maintenance Manual must be stored in its special pouch close to the machine, protected from liquids and anything else that could compromise its legibility.

## 6. ON CONSIGNMENT OF THE MACHINE

When the machine is consigned to the customer, an immediate check must be performed to ensure all the material mentioned in the shipping documents has been received, and also to check the machine has not suffered damage during transportation. If this is the case, the carrier must ascertain the extent of the damage at once, informing our customer service office. It is only by prompt action of this type that the missing material can be obtained, and compensation for damage successfully claimed.

## 7. INTRODUCTORY COMMENT

Any floor scrubbing machine can only work properly and effectively if used correctly and kept in full working order by performing the maintenance operations described in the attached documentation. We therefore suggest you read this instruction booklet carefully and read it again whenever difficulties arise while using the machine. If necessary, remember that our assistance service (organised in collaboration with our dealers) is always available for advice or direct intervention.

## 8. IDENTIFICATION DATA

For technical assistance or to request replacement parts, always give the model, the version and the serial number (written on the relevant plate).

## 9. TECHNICAL DESCRIPTION

The **MMg Base** is a floor scrubbing machine that's capable of handling a wide variety of floors and types of dirt thanks to the mechanical action of two or three brushes and the chemical action of a water-detergent solution. As it advances, it collects the dirt removed, as well as the detergent solution not absorbed by the flooring itself. **The machine must only be used for this purpose.**

## 10. INTENDED USE

This scrubbing machine was designed and built for the cleaning (scrubbing and drying) of smooth, compact flooring in the commercial, residential and industrial sectors by a qualified operator in proven safety conditions. The scrubbing machine is not suitable for cleaning rugs or carpet floors. It is only suitable for use in closed (or at least covered) places.

**ATTENTION:** the machine is not suitable for use in the rain, or under water jets.

**IT IS FORBIDDEN** to use the machine for picking up dangerous dusts or inflammable liquids in places with an explosive atmosphere. In addition, it is not suitable as a means of transport for people or objects.

## 11. SAFETY

Operator cooperation is paramount for accident prevention. No accident prevention programme can be effective without the full cooperation of the person directly responsible for machine operation. The majority of occupational accidents that happen either in the workplace or whilst moving are caused by failure to respect the most basic safety rules. An attentive, careful operator is most effective guarantee against accidents and is fundamental in order to implement any prevention programme.

## 12. SERIAL NUMBER PLATE

The serial number plate is located at the rear of the steering column, and indicates the machine's general characteristics, including its serial number. The serial number is a very important piece of information and should always be provided together with any request for assistance or to purchase spare parts.

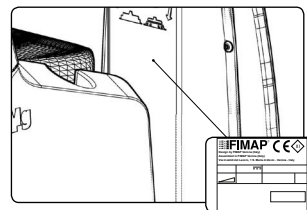

### 13. TECHNICAL DATA

TECHNICAL DATA	SI [KMS]	MMg	MMg 1SL	MMg Cylindrical	MMg Orbital
Rated machine power	W	2025	2140	2090	2090
Working capacity up to	sq.m./h	4000	4500	5000	4500
Working width	mm	755		645	710
Working width with the lateral brush	mm	-	850	940	-
Squeegee width	mm	880			
Central brush head brushes (number -Ø external bristles)	No. / mm	2 - Ø400		-	-
Central brush head brushes (number -Ø external bristles-length)	No. / mm	-	-	2 - (Ø180x616)	-
Pad dimensions (length-width)	No. / mm	-	-	-	1 - (355 - 710)
Rpm of the individual brush on the central brush head	rpm	140		550	-
Number of central brush head oscillations	rpm	-	-	-	3500
Central brush head motor (voltage - nominal power rating)	V / W	24 - 500		24 - 450	24 - 600
Lateral brush head unit lateral movement	mm	-	95	-	-
Lateral brush head brushes (number -Ø external bristles)	No. / mm	-	1 - Ø260 <sup>(4)</sup>	2 - Ø330 <sup>(5)</sup>	-
Lateral brush head brush rotations	rpm	-	150	65	-
Lateral brush head unit motor (voltage - nominal power rating)	V / W	-	24 - 100	24 - 90	-
Maximum weight exerted upon the central brush head	kg	110		60	70
Maximum weight exerted upon the lateral brush head	kg	-	10	5	-
Traction motor (voltage / rated power)	V / W	24 - 600			
Traction wheel (external Ø / width)	mm	Ø300 - 85			
Maximum slope during ascent and descent with the transport programme (weight <sup>(3)</sup> )	%	14			
Maximum slope during ascent and descent with the transport programme (weight <sup>(2)</sup> + operator)	%	18			
Maximum slope during ascent and descent with the working programme (weight <sup>(3)</sup> )	%	7			
Maximum ambient temperature for machine operation	°C	40			
Minimum temperature for using the machine's scrubbing functions	°C	0			
Front wheel (external Ø - width)	mm	Ø225 - 60			
Maximum forward speed in transport mode	km/h	8			
Vacuum motor (voltage - nominal power rating)	V / W	24 - 410			
Vacuum on vacuum head	mbar	118			
Maximum solution tank capacity	l	110			
Maximum recovery tank capacity	l	110			
Turning circle	mm	1950			
Machine dimensions (length - width - height)	mm	1600 - 880 - 1242			
Battery compartment dimensions (width - length - useful height)	mm	525 - 385 - 300			
Recommended battery	V / AhC5	6 - 200			
Machine weight <sup>(1)</sup>	kg	268	278	263	253
Machine weight during transport <sup>(2)</sup>	kg	396	406	391	381
Machine weight during work operations <sup>(3)</sup>	kg	576	586	571	561
Maximum battery weight (recommended)	kg	32	32	32	32
Sound pressure level (ISO 11201) - L pA	dB (A)	63	63	63	63
Uncertainty KpA	dB (A)	1.5	1.5	1.5	1.5
Hand vibration level (ISO 5349)	m/s <sup>2</sup>	< 2.5	< 2.5	< 2.5	< 2.5
Body vibration level (ISO 2631)	m/s <sup>2</sup>	< 0.5	< 0.5	< 0.5	< 0.5
Vibration measurement uncertainty		1.5%	1.5%	1.5%	1.5%

Remarks:

(1) Machine weight: refers to the overall weight of the machine, without the batteries or the operator on board, and with both tanks empty.

(2) Machine weight during transport: refers to the overall weight of the machine with the batteries on board, without the operator on board, and with both tanks empty.

(3) Machine weight during work operations: refers to the machine's overall weight with the batteries on board, with the solution tank full, with the detergent container full (valid for the FSS versions), with the recovery tank empty, and with the operator onboard (theoretical weight of 70kg).

(4) Lateral brush associated with the scrubbing brush head.

(5) Lateral brush associated with the sweeping brush head.

## 14. SYMBOLS USED ON THE MACHINE



**Main switch symbol:**  
Applied to the control panel, positioned on the front of the machine, to indicate the main switch.



**Lateral brush head shifting control label (1SL versions):**  
Applied in the vicinity of the steering column to indicate the lateral brush head's shifting control button.



**Acoustic signalling device control label:**  
Applied in the vicinity of the steering column to indicate the acoustic signalling device's control button.



**Detergent solution recycle control button (FLR versions):**  
Applied in the vicinity of the steering column to indicate the detergent solution recycle control button.

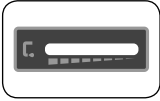

**Label for detergent solution tap command:**  
Applied in the vicinity of the control column to identify the detergent solution tap's control lever.



**Symbol of maximum temperature for filling the solution tank:**  
Applied to the left-hand side of the machine's solution tank to indicate the maximum temperature of the water that can be used to safely fill the solution tank.

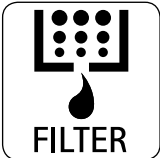

**Filter body position symbol:**  
Applied to the left-hand side of the machine to indicate the position of the solution tank's filter.



**Extra pressure activation/deactivation lever position symbol:**  
Applied to the central brush head's extra pressure activation/deactivation lever.



**Reverse gear activation/deactivation lever position symbol:**  
Applied to the reverse gear activation/deactivation lever.



**Label indicating the need to read the Use and Maintenance Manual:**  
Applied in the vicinity of the steering column in order to remind the operator to read the user and maintenance manual before using the machine.



**Treading ban label:**  
Located on the machine, to identify the surfaces that must not be trodden on (risk of personal injury or damage to the machine).



**Label warning about the risk of crushed hands:**  
Indicates danger to hands due to crushing between two surfaces.

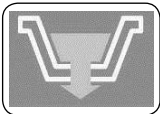

**Recovery tank drainage hose symbol:**  
Applied to the back of the machine to identify the recovery tank's drainage hose.

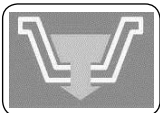

**Solution tank drainage cap symbol:**  
Applied to the back of the machine to identify the solution tank's drainage cap.



**Warning label (versions without built-in battery charger):**  
Affixed to the machine in order to warn the operator to read the user and maintenance manual (this document) before using the machine for the first time. Also indicates the applicable procedures for properly caring for the machine itself.



**Solution tank filter daily care warning label:**  
Applied to the machine to remind the operator to clean the solution tank after each use.



**Warning label (versions with built-in battery charger):**  
Affixed to the machine in order to warn the operator to read the user and maintenance manual (this document) before using the machine for the first time. It also contains a **summary** of the procedures to be applied in order to properly charge the batteries.

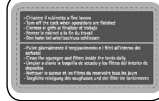

**Warning label (versions with built-in battery charger):**  
Applied to the machine to remind the operator of the applicable procedures for properly caring for the machine itself.



**Vacuum motor filter label:**  
Applied inside the vacuum cover to identify the vacuum motor intake air filter, and also serves to remind the operator to clean the filter after each machine use.



**Brush head body working position symbol:**  
Applied to the steering column to indicate the brush head control lever's direction of rotation for bringing the brushes to their working position.



**Brush head body standby position symbol:**  
Applied to the steering column to indicate the brush head control lever's direction of rotation for bringing the brushes to their standby position.



**Squeegee body working position symbol:**  
Applied to the steering column to indicate the squeegee control lever's direction of rotation for bringing the squeegee to its working position.



**Squeegee body standby position symbol:**  
Applied to the steering column to indicate the squeegee control lever's direction of rotation for bringing the squeegee to its standby position.

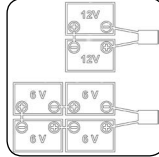

**Battery connection symbol:**  
Applied beneath the recovery tank to indicate how to connect the 6V or 12V batteries in order to obtain a total voltage of 24V.

## 15. SYMBOLS USED ON THE SERIAL NUMBER PLATE

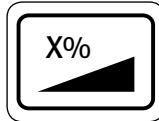

**Maximum gradient symbol:**  
Used on the machine serial number plate, to indicate the maximum gradient that can be safely handled in working mode.

**16. MACHINE PREPARATION**

**1. HANDLING THE PACKAGED MACHINE**

The machine's overall weight including packaging is 000Kg.

**NOTE:** it is recommended that all the packaging components be kept for any future machine transportation.

**DANGER:** move the packaged product with handling equipment that complies with legal requirements regarding size and mass of the packaging.

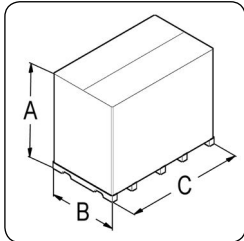

A	1420mm
B	1024mm
C	1760mm

**2. HOW TO UNPACK THE MACHINE**

The machine is shipped in specific packaging. To remove it, proceed as follows:

- Place the lower part of the outer packaging in contact with the floor.

**NOTE:** use the pictograms printed on the box as a reference.

- Remove the outer package.

**WARNING:** the machine is contained in specific packaging materials, whose elements (plastic bags, staples, etc.) can pose potential hazards, and must not be left within reach of children, disabled persons, etc.

- Remove the boxes containing the disc brushes and squeegee body from the machine.

**CAUTION:** these operations must be carried out using protective gloves to avoid any possible contact with the edges or tips of metal objects.

- Insert a ramp in the rear part of the machine.

**ATTENTION:** the ramp gradient must not be such as to cause damage to the machine as it comes down.

- The machine is fixed to the pallet with wedges (1) that block the wheels (Fig.1). Remove these wedges.

- Check to make sure that the main switch on the control panel has been set to its "0" position. If this is not the case, turn the key (2) a quarter turn to the left (Fig.2). Remove the key from the main switch.

- Grip the handle (3) and raise the recovery tank to the maintenance position (Fig.3).

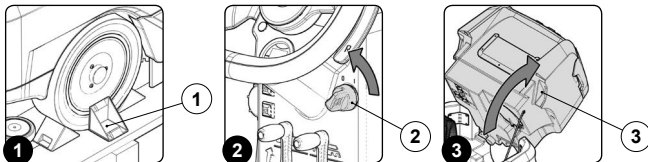

- Connect the backup battery carriage's connector to the machine's main system connector (Fig.4).

- Grip the handle (3) and lower the recovery tank to its working position (Fig.5).

- Sit on the driver's seat.

- Insert the key (1) into the main switch on the control panel. Set the main machine switch to its "I" position, by turning the key a quarter turn to the right (Fig.6).

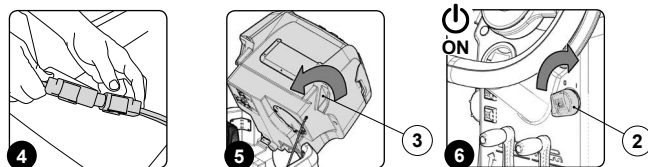

- Turn the brush head control level (4) anti-clockwise (Fig.7); in this manner the brush head's body will be raised off the pallet.

- Turn the squeegee control lever (5) clockwise (Fig.8) to raise the squeegee body off the pallet.

- Engage the reverse gear using the reverse gear activation/deactivation lever (6) (Fig.9).

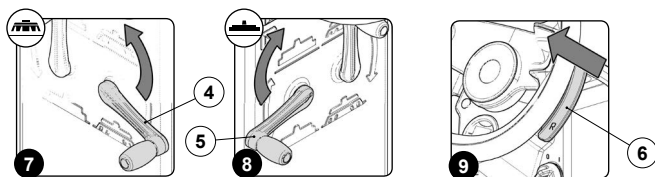

- Press the drive pedal (7) (Fig.10) to begin moving the machine.
- Drive the machine down the ramp.

**ATTENTION:** during this operation, check there are no people or objects near the machine.

- Bring the main switch to its "0" position by turning the key (1) a quarter turn anti-clockwise (Fig.2). Remove the key from the main switch.
- Get off the machine.
- Grip the handle (2) and raise the recovery tank to its maintenance position (Fig.3).
- Disconnect the backup battery carriage's connector from the machine's main system connector (Fig.4).
- Grip the handle (4) and lower the recovery tank to its working position (Fig.5).

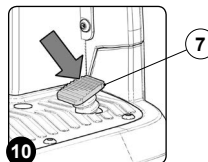

**3. HOW TO MOVE THE MACHINE**

To transport the machine safely, proceed as follows:

**DANGER:** before starting any task, make sure the current regulations concerning the safe transport of dangerous substances are scrupulously observed.

- Check to make sure that the solution tank and the recovery tank are empty. If this is not the case, empty them (see the sections titled "EMPTYING THE SOLUTION TANK" and "EMPTYING THE RECOVERY TANK").
- Sit on the driver's seat.
- Insert the key (1) into the main switch on the control panel. Bring the main switch to its "I" position by turning the key (1) a quarter turn to the right (Fig.1).
- Turn the brush head control lever (2) anti-clockwise (Fig.2); in this manner the brush head's body will be raised off the floor.
- Turn the squeegee control lever (3) clockwise (Fig.3) to raise the squeegee body off the floor.

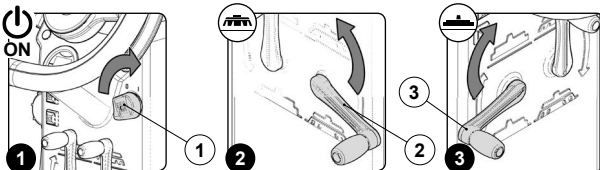

- Press the drive pedal (4) (Fig.4) to begin moving the machine.
- Use a ramp to move the machine up onto the transport vehicle.

**CAUTION:** during this operation, check there are no people or objects near the machine.

**NOTE:** the ramp gradient must not be such as to cause damage to the machine as it goes up.

- Position the machine on the means of transport, and set the main switch to its "0" position by turning the key (1) a quarter turn anti-clockwise (Fig.5). Remove the key from the main switch.
- Get off the machine.
- Grip the handle (5) and raise the recovery tank to its maintenance position (Fig.6).

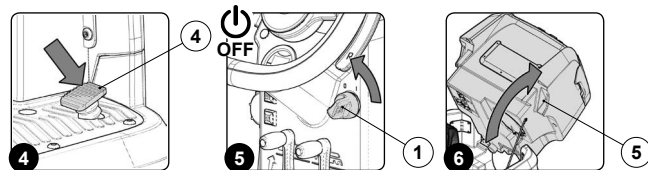

- Disconnect the battery connector from the machine's main system connector (Fig.7).
- Grip the handle (5) and lower the recovery tank to its working position (Fig.8).

**WARNING:** secure the device according to the directives in force in the country of use, so that it cannot slide or tip over.

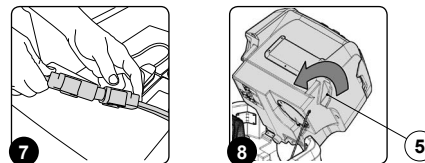

#### 4. SECURING THE MACHINE

The procedure for securing the machine, thus allowing the operations to be performed under conditions of complete safety, is as follows:

1. Make sure the solution tank is empty. If this is not the case, empty it (read "[EMPTYING THE SOLUTION TANK](#)").
2. Make sure the recovery tank is empty. If this is not the case, empty it (read "[EMPTYING THE RECOVERY TANK](#)").
3. Bring the main switch to its "0" position by turning the key (1) a quarter turn anti-clockwise (Fig.1). Remove the key from the instrument panel.
4. Get off the machine.
5. Grip the handle (2) and raise the recovery tank to the maintenance position (Fig.2).
6. Disconnect the battery connector from the machine's main system connector (Fig.3).
7. Grip the handle (2) and turn the recovery tank to its working position (Fig.4).

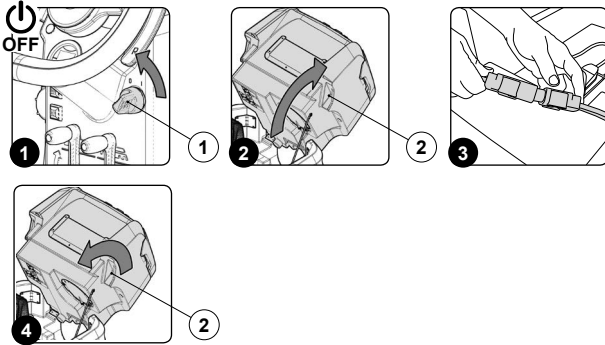

#### 5. TYPE OF BATTERY TO BE USED

Power to the machine must be supplied by four sealed traction batteries with gas recombination or gel technology. The batteries must meet the requirements laid out in the norms: CEI EN 60254-1:2005-12 (CEI 21-5) + CEI EN 60254-2:2008-06 (CEI 21-7). In order to ensure good operating performance, it is recommended to use four 6V MFP 210 Ah/C5 batteries.

#### 6. BATTERY MAINTENANCE AND DISPOSAL

For battery maintenance and recharging, respect the instructions provided by the battery manufacturer. When the batteries reach the end of their service life, they must be disconnected by specialized and properly trained personnel, and must be subsequently removed from the battery compartment using suitable lifting devices.

**NOTE:** dead batteries are classified as dangerous waste and as such must be delivered to an authorised body for disposal.

#### 7. INSERTING THE BATTERIES INTO THE MACHINE

The batteries must be housed in the special compartment beneath the recovery tank and should be handled using lifting equipment that is suitable in terms of both weight and its coupling system.

**DANGER:** make sure that you comply with the accident prevention regulations in force in the country where you work or with DIN EN 50272-3 and DIN EN 50110-1, before any handling of the batteries.

**CAUTION:** to prevent an accidental short circuit use insulated tools to connect the batteries, and do not place or drop metal objects on the battery. Remove rings, watches and any clothing with metal parts that may come into contact with the battery terminals.

The various phases for inserting the batteries in the battery compartment are as follows:

1. Make sure the machine is in a safe condition (read "[MACHINE SAFETY](#)").
2. Move to the left hand side of the machine and open the left lateral carter (1) (Fig.1).
3. Check to make sure that the electronic brake is engaged, and turn the lever on the rear left portion of the machine (2) clockwise (Fig.2). Close the left lateral carter (1).
4. Grip the handle (3) and raise the recovery tank to the maintenance position (Fig.3).

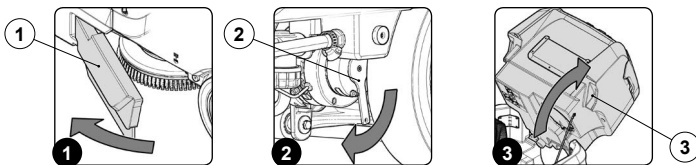

**NOTE:** for battery maintenance and daily recharging, you must fully respect the indications provided by the manufacturer or retailer.

**CAUTION:** all installation and maintenance operations must be carried out by specialised personnel.

**NOTE:** before installing the battery, clean the battery compartment. Check that the connectors on the cables supplied are functioning correctly.

**ATTENTION:** check that the characteristics of the battery that you are looking to use are appropriate for the type of work to be performed. Check the battery charge and the condition of the contacts on the battery.

**NOTE:** you are advised to only lift and move the batteries with lifting and transportation means suitable for the specific weight and size

**CAUTION:** the lifting hooks must not damage the blocks, connectors or cables.

**NOTE:** before inserting the batteries, remember to cover the terminals with a little grease to protect them against external corrosion.

5. House the batteries in the compartment, positioning the poles "+" and "-" opposite each other.

#### 8. CONNECTING BATTERIES TO THE SYSTEM OF THE APPLIANCE

The batteries should be connected so as to obtain a total voltage of 24V.

**ATTENTION:** it is recommended that all installation and maintenance operations be carried out by expert personnel, trained at the specialised assistance centre.

**CAUTION:** to prevent an accidental short circuit use insulated tools to connect the batteries, and do not place or drop metal objects on the battery. Remove rings, watches and any clothing with metal parts that may come into contact with the battery terminals.

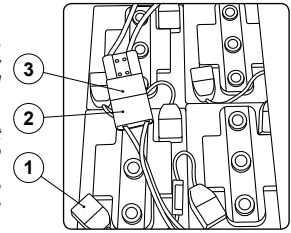

The various phases for inserting the batteries in the battery compartment are as follows:

1. Using the supplied jumper cable (1), connect the batteries to the "+" and "-" poles in sequence.
2. Connect the batteries' connector cable (2) to the "+" and "-" poles to obtain a voltage of 24V at the terminals.
3. Connect the electric system connector (3) to the battery connector (2).

#### 9. RECHARGING THE BATTERIES

The batteries must be charged prior to first use, and whenever they no longer provide sufficient power.

**ATTENTION:** to avoid any permanent damage to the batteries, it is essential to avoid their complete discharge, begin recharging them within a few minutes of noting the "discharged batteries" signal.

**ATTENTION:** never leave the batteries completely discharged, even if the device is not being used.

1. Bring the appliance to the zone where the batteries are charged.
2. Make sure the machine has been secured (see the section titled "[SECURING THE MACHINE](#)").

**ATTENTION:** park the appliance in an enclosed place, on a flat surface; near the appliance there must be no objects that could either damage it, or be damaged through contact with it.

**ATTENTION:** the room used to recharge the batteries must be adequately ventilated to prevent the accumulation of gases that leak from batteries.

3. Grip the handle (1) and raise the recovery tank to its maintenance position (Fig.1).

To recharge the batteries without the built-in battery charger, proceed as follows:

- A. Disconnect the electrical system's connector (2) from the battery connector (3) (Fig.2).

**ATTENTION:** the following operations must be carried out by qualified personnel. An incorrect connection of the connector may cause a malfunction of the device.

- B. Connect the external battery charger cable to the battery connector.

**NOTE:** the coupling connector of the battery charger is consigned inside the bag containing this instruction booklet, and must be assembled on the cables of the battery charger as indicated in the instructions.

**ATTENTION:** before connecting the batteries to the battery charger, make sure it is suitable for the batteries used.

**NOTE:** carefully read the use and maintenance instructions of the battery charger that is used for charging.

**CAUTION:** keep the recovery tank open for the duration of the battery recharging cycle to allow gas fumes to escape.

- C. Once the recharge cycle has been completed, disconnect the battery charger's cable from the battery connector.

- D. Connect the electrical system's connector (2) to the battery connector (3) (Fig.2).

- E. Grip the handle (1) and turn the recovery tank to its working position (Fig.3).

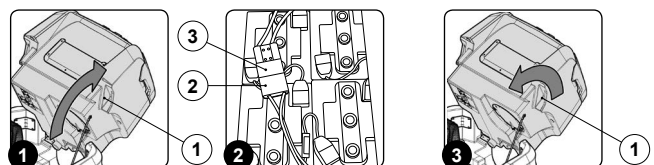

To recharge the batteries with the on-board battery charger proceed as follows:

**ATTENTION:** the following operations must be carried out by qualified personnel. An incorrect connection of the connector may cause a malfunction of the device.



**NOTE:** carefully read the use and maintenance instructions of the battery charger that is used for charging.

I. Remove the cap (4) from the battery charger socket (Fig.4).

**CAUTION:** before connecting the batteries to the battery charger, make sure it is suitable for the batteries used.

**WARNING:** Before inserting the battery charger's power cable into the socket (5), make sure that no condensate or other types of liquid are present (Fig.5).

**NOTE:** the battery charger power cable is delivered inside the bag containing this instruction booklet.

II. Connect the battery charger's power cable to the socket on the battery charger itself.

III. Plug the battery charger cable into the mains socket.

**CAUTION:** keep the recovery tank open for the duration of the battery recharging cycle to allow gas fumes to escape.

IV. When the recharge cycle is complete, disconnect the battery charger cable from the mains.

V. Disconnect the battery charger's power cable from the socket on the battery charger itself.

VI. Apply the cap (4) to the battery charger's socket (Fig.4).

VII. Grip the handle (1) and turn the recovery tank to its working position (Fig.6).

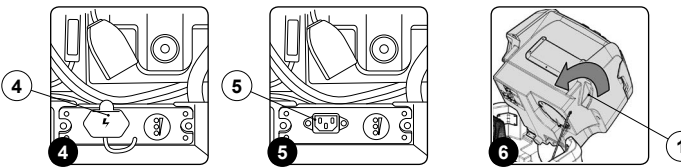

## 10. ASSEMBLING THE SQUEEGEE

For packaging reasons, the squeegee body comes disassembled from the machine. In order to mount it on the squeegee support, do the following:

1. Sit on the driver's seat.
2. Insert the key (1) into the main switch on the control panel. Bring the main switch to its "I" position by turning the key (1) a quarter turn clockwise (Fig.1).
3. Turn the squeegee control lever (2) anti-clockwise (Fig.2) to raise the squeegee body off the floor.
4. Once the squeegee body has arrived in its resting position, perform the procedure for securing the machine (see the section titled "SECURING THE MACHINE").

**CAUTION:** these operations must be carried out using protective gloves to avoid any possible contact with the edges or tips of metal objects.

5. Unscrew the knobs (3) present in the squeegee body's pre-assembly (Fig.3).

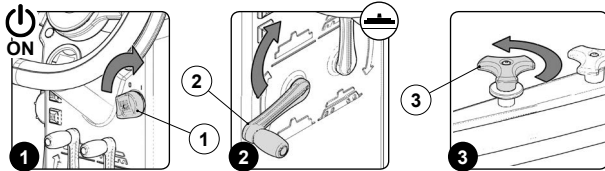

6. First, insert the left pin (4) on the squeegee body into the left slit (5) in the squeegee support (Fig.4), so that the bushing adheres to the walls of the slit in the squeegee support.

7. Repeat the same operation for the right pin.

8. Insert the vacuum tube (6) into the sleeve (7) in the squeegee body (Fig.5).

**NOTE:** Although the squeegee comes pre-adjusted, it is nevertheless recommended to read the section titled "ADJUSTING THE SQUEEGEE BODY'S RUBBER BLADES".

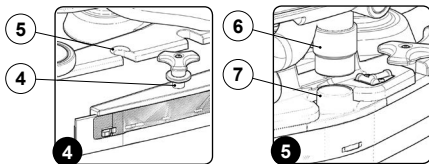

## 11. FILLING THE SOLUTION TANK

Before filling the solution tank, carry out the following steps:

1. Take the machine to the usual place for filling the solution tank.
2. Perform the procedure for securing the machine ( see the section titled "SECURING THE MACHINE").
3. Check to make sure that the solution tank drainage cap (1) is closed. If this is not the case, close it (Fig.1).
4. Check to make sure that the water system's filter cap (2), located on the rear left-hand side of the machine, is closed, and close it if necessary (Fig.2).

The solution tank can be filled with water in two different ways:

- Removing the cap/measuring device (3) and filling the solution tank by means of a rubber hose or a bucket (Fig.3).
  - Using the filler hose (4) (Fig.3), which supports the water hose on its own. In this case, be sure to remove the cap/measuring device (3) in order to allow the air to vent properly.
5. Fill with clean water, at a temperature not higher than 50°C and not lower than 10°C. The amount inside the tank can be seen by means of the level pipe on the front left of the seat.

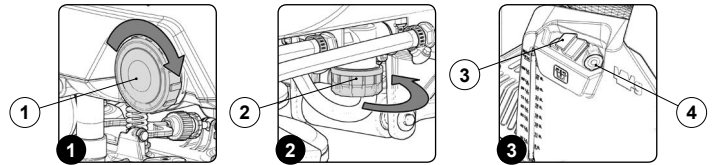

## 12. DETERGENT SOLUTION

After filling the solution tank with clean water add the liquid detergent to the tank in the concentration and manner indicated on the detergent manufacturer's label. To prevent the formation of an excessive amount of foam that could damage the vacuum motor, use the minimum percentage of detergent required.

**CAUTION:** protective gloves should always be worn before handling detergents or acidic or alkaline solutions, to avoid serious injury to the hands.

**ATTENTION:** always use detergents whose manufacturer's label indicates their suitability for scrubbing machines. Do not use acid or alkaline products or solvents without this indication.

**ATTENTION:** always use low-foam detergent. To avoid the production of foam, put a minimum quantity of antifoam liquid in the recovery tank before starting to clean. Do not use pure acids.

**ATTENTION:** The filler cap can be used as measuring device for the detergent to be added to the solution tank; the cap features moulded notches identifying the percentage of detergent, ranging from a minimum of 0.1% to a maximum of 0.5%.

## 17. PREPARING TO WORK

Before beginning to work, it is necessary to:

1. Make sure the recovery tank is empty. If this is not the case, empty it (read "EMPTYING THE RECOVERY TANK").
2. Check that the amount of detergent solution present in the solution tank is sufficient for the type of work to be performed. If this is not the case, top up the solution tank (see the sections titled "FILLING THE SOLUTION TANK" and "DETERGENT SOLUTION").
3. Check that the squeegee rubbers are in good working condition. If not, carry out maintenance (see "REPLACING THE SQUEEGEE RUBBER BLADES").
4. Check that the status of the brushes is suitable for the work to be performed. If this is not the case, take appropriate measures to have them serviced.
5. Check that the main switch (1) on the control panel has been set to its "0" position (Fig.1). If this is not the case, turn the key a quarter turn anti-clockwise. Remove the key from the instrument panel.
6. Grip the handle (2) and raise the recovery tank to the maintenance position (Fig.2).
7. Connect the battery connector (3) to the machine's main system connector (4) (Fig.3).
8. Grip the handle (2) and lower the recovery tank to its working position.
9. Check that the electronic brake is engaged. If this is not the case, turn the lever (5) anti-clockwise. The traction gearmotor is located on the rear left-hand side of the machine (Fig.4).

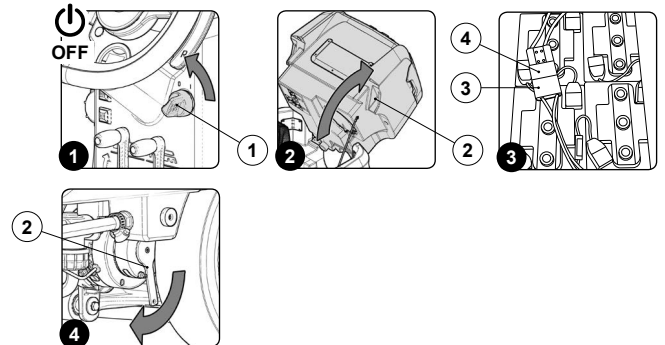

## 18. WORK

### 1. SCRUBBING WITH DRYING

To carry out "SCRUBBING AND DRYING" tasks, proceed as follows:

1. Make all the checks listed in "PREPARING TO WORK".
  2. Sit on the driver's seat.
  3. Insert the key (1) into the main switch on the control panel. Bring the main switch to its "I" position by turning the key (1) a quarter turn clockwise (Fig.1).
- NOTE:** As soon as the machine turns on, the control board will perform a diagnostics procedure, during which the red LED indicator (2) on the control panel (Fig.2) will remain on.
- NOTE:** If the control board's diagnostics procedure returns a positive outcome, the red LED indicator (2) on the control panel (Fig.2) will turn off, and an acoustic signal will sound indicating that the work operations may be initiated.
4. Lower the brush head's body by turning the brush head control lever (3) on the rear part of the steering column (Fig.3).

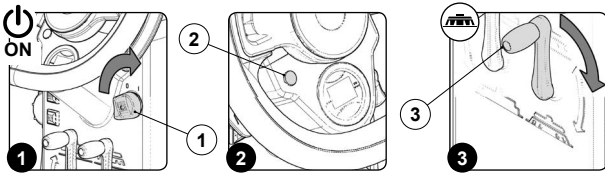

5. Lower the squeegee body by turning the squeegee control lever (4) on the rear part of the steering column (Fig.4).
6. Check to make sure that the detergent solution tap is completely open. If this is not the case, adjust the lever (5) on the left-hand side of the steering column (Fig.5).
7. Press the drive pedal (6) (Fig.6) to begin moving the machine.

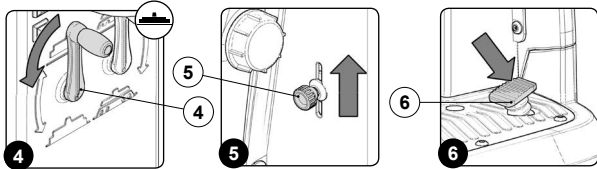

**(i) NOTE:** Once the drive pedal is pressed, the brush head body and the squeegee body will begin to descend into their working positions.

**(i) NOTE:** Once the brush head body and the squeegee body have reached their working positions, the relative motors will enter into function, and the solenoid valve will dispense the detergent solution.

8. During the first few meters, check that the detergent solution coming out is appropriate to the work to be carried out; if not, adjust it after reading the section "ADJUSTING DETERGENT SOLUTION".

The appliance will now begin to work with full efficiency until the battery is flat or until the detergent solution has finished. During the first few metres, check that there is sufficient solution and that the squeegee is drying correctly.

**(i) NOTE:** If the drive pedal is released during the scrubbing/drying operation, the brush motor and the solenoid valve will be deactivated, and the vacuum motor will continue to function for a few seconds in order to ensure that all the liquid present in the vacuum hose is extracted.

**(i) NOTE:** when filling the solution tank, it is good practice to empty the recovery tank using the special drainage hose.

## 2. SCRUBBING WITHOUT DRYING

To carry out "SCRUBBING WITHOUT DRYING" tasks, proceed as follows:

1. Make all the checks listed in "PREPARING TO WORK".
  2. Sit on the driver's seat.
  3. Insert the key (1) into the main switch on the control panel. Bring the main switch to its "I" position by turning the key (1) a quarter turn clockwise (Fig.1).
- (i) NOTE:** As soon as the machine turns on, the control board will perform a diagnostics procedure, during which the red LED indicator (2) on the control panel (Fig.2) will remain on.
- (i) NOTE:** If the control board's diagnostics procedure returns a positive outcome, the red LED indicator (2) on the control panel (Fig.2) will turn off, and an acoustic signal will sound indicating that the work operations may be initiated.
4. Lower the brush head's body by turning the brush head control lever (3) on the rear part of the steering column (Fig.3).

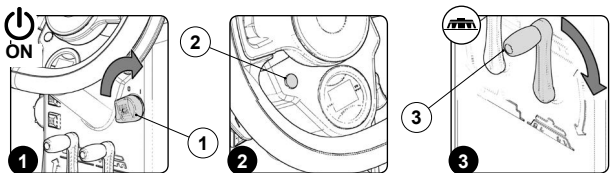

5. Check to make sure that the detergent solution tap is completely open. If this is not the case, adjust the lever (4) on the left-hand side of the steering column (Fig.4).
6. Press the drive pedal (5) (Fig.5) to begin moving the machine.

**(i) NOTE:** Once the drive pedal has been pressed, the brush head body will begin to descend into its working position.

**(i) NOTE:** Once the brush head body has reached its working position, the brush gearmotors will enter into function and the solenoid valve will begin to dispense the detergent solution.

7. During the first few meters, check that the detergent solution coming out is appropriate to the work to be carried out; if not, adjust it after reading the section "ADJUSTING DETERGENT SOLUTION".

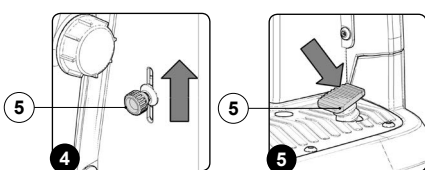

The appliance will now begin to work with full efficiency until the battery is flat or until the detergent solution has finished. During the first few metres, check that there is sufficient solution.

**(i) NOTE:** If the drive pedal is released during the scrubbing without drying operation, the brush motor and the solenoid valve will be deactivated.

**(i) NOTE:** when filling the solution tank, it is good practice to empty the recovery tank using the special drainage hose.

## 3. DRYING

To carry out "DRYING WITHOUT SCRUBBING" tasks, proceed as follows:

1. Make all the checks listed in "PREPARING TO WORK".
2. Sit on the driver's seat.
3. Insert the key (1) into the main switch on the control panel. Bring the main switch to its "I" position by turning the key (1) a quarter turn clockwise (Fig.1).

**(i) NOTE:** As soon as the machine turns on, the control board will perform a diagnostics procedure, during which the red LED indicator (2) on the control panel (Fig.2) will remain on.

**(i) NOTE:** If the control board's diagnostics procedure returns a positive outcome, the red LED indicator (2) on the control panel (Fig.2) will turn off, and an acoustic signal will sound indicating that the work operations may be initiated.

4. Lower the squeegee body by turning the squeegee control lever (3) at the rear of the steering column (Fig.3).

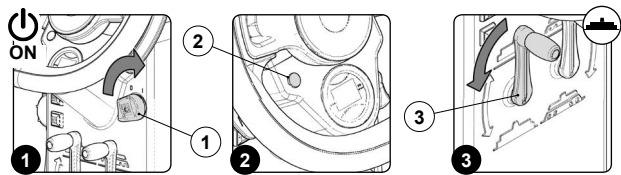

5. Press the drive pedal (4) (Fig.4) to begin moving the machine.

**(i) NOTE:** Once the drive pedal has been pressed, the squeegee body will begin to descend into its working position.

**(i) NOTE:** Once the squeegee body has reached its working position, the vacuum motor will enter into function.

The machine will now work at its maximum efficiency level until the batteries run down.

**(i) NOTE:** If the drive pedal is released during the drying operation, the vacuum motor will continue to operate for a few seconds in order to ensure that all the liquid present in the vacuum hose is extracted.

**⚠ The drying without scrubbing operation should only be carried out if the machine was previously used to carry out a scrubbing without drying operation.**

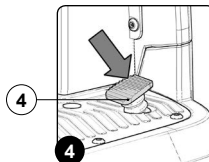

## 4. REGULATING THE DETERGENT SOLUTION

To adjust the amount of detergent solution on the brush, proceed as follows:

1. Open the tap's output flow to maximum, and shift the knob on the left hand side of the steering column (1) (Fig.1) upward.
2. When the drive pedal is pressed (2) (Fig.2), the brush gearmotors will enter into function and the solenoid valve will distribute detergent solution to the brushes.
3. During the first few metres, check to make sure that the quantity of solution is sufficient to wet the floor, but not so much as to come out of the splash guard. The detergent leakage can be adjusted using the knob (1) on the steering column.

**⚠ ATTENTION:** When the knob (1) (Fig.1) is moved upwards, the amount of detergent solution distributed to the brushes increases. When the knob (1) (Fig.3) is moved downwards, the amount of detergent solution distributed to the brushes decreases.

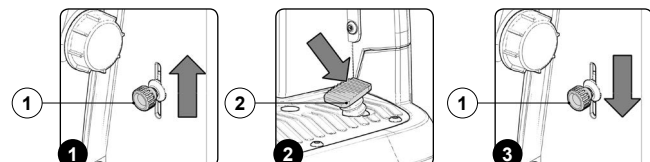



## 5. REVERSE GEAR

This machine is equipped with electronic traction control. To reverse, proceed as follows:

1. Engage the "REVERSE GEAR ACTIVATION/DEACTIVATION" lever (1) underneath the steering wheel (Fig.1).
2. Press the drive pedal (2) (Fig.2); in this manner the machine will begin to move in reverse.

**CAUTION:** the reverse speed is lower than the forward speed to comply with current health and safety standards.

- NOTE:** In order to disengage the reverse gear, disengage the lever (1) underneath the steering wheel (Fig.1).
- NOTE:** Once the lever has been engaged (1), the acoustic signalling device will be activated in order to signal that the machine's reverse gear has been engaged.
- NOTE:** If the reverse gear is engaged with the squeegee in its working position, once the drive pedal is pressed, the machine will begin to move in reverse and the squeegee body will be raised into its resting position.
- NOTE:** If the reverse gear is engaged with the brush head in its working position, once the drive pedal is pressed, the machine will begin to move in reverse and the brush head will remain in its working position, but the solenoid valve will stop dispensing detergent solution to the brushes.

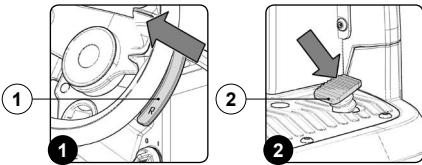

## 6. EXTRA BRUSH HEAD PRESSURE

This machine is capable of increasing the pressure exerted upon the brushes during the work cycle. This can be done in the following manner:

1. Check to make sure that the brush head body is in contact with the floor. If this is not the case, adjust the brush head control lever (1) on the steering column (Fig.1).
2. Engage the "EXTRA-PRESSURE ACTIVATION/DEACTIVATION" lever (2) underneath the steering wheel (Fig.2).
3. Press the drive pedal (3) (Fig.3) to initiate the machine's working cycle.

**NOTE:** Once the lever (2) (Fig.4) has been engaged, the red indicator light (4) on the steering column will turn on to indicate that the extra-pressure function has been enabled.

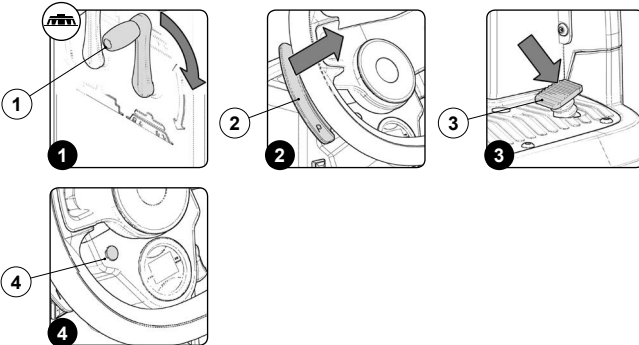

## 7. ACOUSTIC SIGNALLING DEVICE

The machine is equipped with an acoustic signalling device. If an acoustic signal needs to be emitted, simply press the button (1) on the control panel (Fig.1).

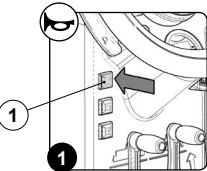

## 8. WORKING HEADLIGHTS (OPTIONAL)

Upon request, the machine can be equipped with front and rear working lights. These lights can be turned on by setting the main switch to its "I" position, or rather by turning the key a quarter turn to the right (Fig.1).



## 9. EMERGENCY BUTTON

If any problems are encountered during the work operations, press the emergency button (1) on the electrical system's cover carter (Fig.1).

**CAUTION:** This command interrupts the electrical circuit between the batteries and the machine system.

- NOTE:** After having stopped and resolved the problem, the work operations can be resumed by doing the following:
  - Bring the main switch to its "0" position by turning the key (2) a quarter turn anti-clockwise (Fig.2).
  - Disengage the mushroom-head emergency button (1) (Fig.3).
  - Bring the main switch to its "I" position by turning the key (2) a quarter turn clockwise (Fig.4).

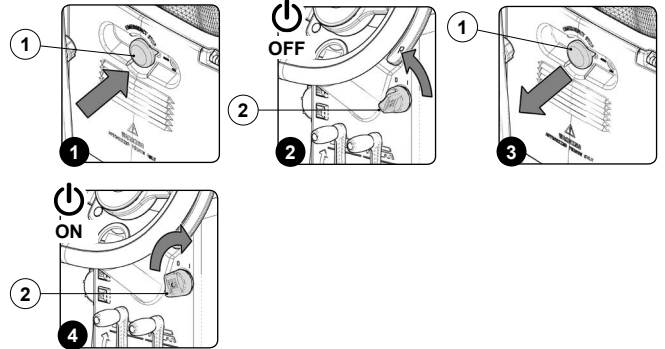

## 10. HOUR METER

The control display is located on the control panel, and the screen that appears after the start-up screen displays the machine's total usage time. The digits that precede the "." symbol identify hours, whilst the digit that follows it indicates hour decimals (an hour decimal corresponds to six minutes). When the "hour glass" symbol (1) is flashing it indicates that the hour meter is counting the appliance's operating time.

## 11. BATTERY CHARGE LEVEL INDICATOR

The control panel is equipped with a control display. The graphic symbol that identifies the charge level of batteries appears at the bottom of the control display. The indicator consists of charge level symbols (2). When the minimum remaining charge is reached, the graphic symbol (2) will start to blink, and will turn off after a few seconds, after which the symbol (3) will start to blink. Under these conditions, the machine must be brought to the battery charging area.

**NOTE:** A few seconds after the battery charge reaches the critical level (2), the brush gearmotors will shut off automatically. With the remaining charge it is possible to complete the drying process before starting the recharge.

**NOTE:** A few seconds after the battery charge level reaches the discharge level (2), the vacuum motor switches off automatically.

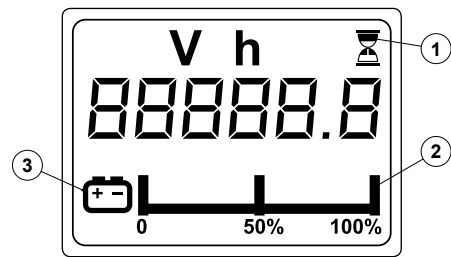

## 12. LATERAL BRUSH 1SL (SCRUBBING VERSION)

If the lateral brush needs to be used during the floor scrubbing operations, and therefore with the brush head in its working position, press the lateral brush head activation/deactivation button (1) on the left-hand side of the steering column (Fig.1).

**NOTE:** When the lateral brush is in function, the LED indicator light inside the button (1) will be on.

**NOTE:** By pressing the button (1), the lateral brush head will begin to move towards the outside of the machine, and the solenoid valve will only begin to dispense the detergent solution once it has reached its working position.

**NOTE:** In order to bring the lateral brush head back to its resting position, press the button (1).

**NOTE:** If the central brush head is raised with the lateral brush head in its working position, the lever (2) on the steering column (Fig.2) can be turned in order to bring the lateral brush head back to its resting position as well. The LED indicator inside the button (1) will nevertheless remain on to indicate that if the central brush head is brought back to its working position, the lateral one will move to the right.

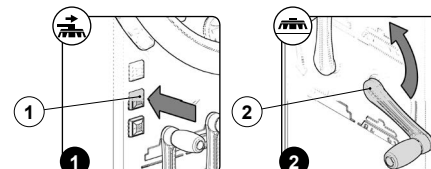

### 13. LATERAL BRUSH 2SL (SWEEPING VERSION)

If the lateral brushes need to be used during the floor scrubbing operations, and therefore with the brush head in its working position, press the lateral brush head activation/deactivation button (1) on the left-hand side of the steering column (Fig.1).

- i** **NOTE:** When the lateral brush is in function, the LED indicator light inside the button (1) will be on.
- i** **NOTE:** By pressing the button (1) the lateral brushes will begin to move downwards, and the gearmotors will only enter into function once they have reached their working positions.
- i** **NOTE:** In order to bring the lateral brushes back to their resting positions, press the button (1).
- i** **NOTE:** If the central brush head is raised with the lateral brushes in their working positions, the lever (2) on the steering column (Fig.2) can be turned in order to bring the lateral brushes back to their resting positions as well. The LED indicator inside the button (1) will nevertheless remain on to indicate that if the central brush head is brought back to its working position, the lateral one will move to the right.

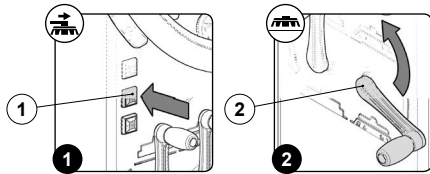

### 14. DETERGENT SOLUTION RECYCLING (FLR VERSION)

If the machine being utilized features the FLR system for recycling the detergent solution, once the machine has been started up, press the FLR system activation/deactivation button (1) (Fig.1). Once the work operations have been completed, remember to shut off the FLR system by pressing the button (1).

- i** **NOTE:** When the FLR system is in function, the LED indicator light inside the button (1) will be on.
- i** **NOTE:** At the end of the workday, perform all the procedures listed in the "RECOMMENDED PERIODIC MAINTENANCE" section.

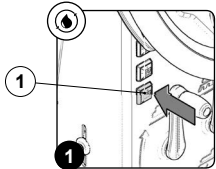

### 15. OVERFLOW DEVICE

The machine is equipped with an electro-mechanical device (float), located in the back of the recovery tank, which deactivates the vacuum motor's control circuit when the recovery tank is full.

- i** **NOTE:** The electro-mechanical float only deactivates the electrical circuit when the mechanical device (float) is engaged for at least four seconds.

If this is the case, proceed as follows:

1. Deactivate the dispensing of the detergent solution by shifting the knob (1) on the left-hand side of the steering column downwards (Fig.1).
2. Raise the brush head's body by turning the brush head control lever (2) on the rear part of the steering column (Fig.2).
3. Raise the squeegee body by turning the squeegee control lever (3) at the rear of the steering column (Fig.3).
4. Bring the machine to the designated place for emptying the recovery tank.
5. Shut off the machine by turning the key on the main switch (4) a quarter turn to the left (Fig.4).

- i** **NOTE:** The main switch (5) is located at the rear of the steering column.
- 6. Empty the recovery tank (see the section titled "EMPTYING THE RECOVERY TANK").
- i** **NOTE:** The machine will only resume functioning correctly after the next start-up.

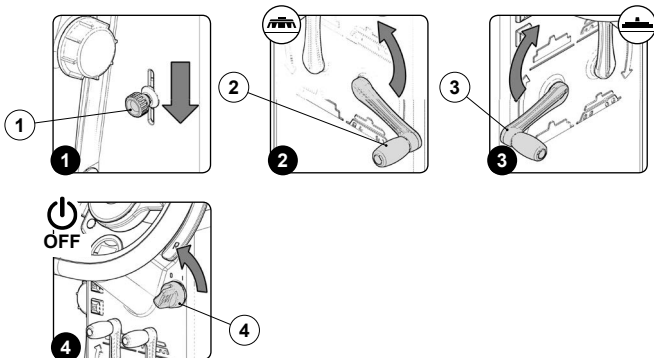

### 19. AT THE END OF THE WORK

At the end of the work, and before carrying out any type of maintenance, perform the following operations:

1. Turn the brush head control level (1) anti-clockwise (Fig.1); in this manner the brush head's body will be raised off the floor.
2. Turn the squeegee control lever (2) clockwise (Fig.2) to raise the squeegee body off the floor.
3. Press the drive pedal (3) (Fig.3) to begin moving the machine.

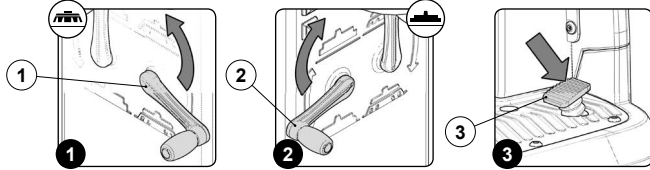

4. Take the appliance to the dedicated dirty water drainage area.
5. Shut off the machine by turning the key on the main switch (4) a quarter turn to the left (Fig.4). Remove the key from the instrument panel.
6. Carry out all the procedures listed in the paragraph "RECOMMENDED PERIODIC MAINTENANCE" indicated in the column "AT THE END OF THE WORK".
7. Sit on the driver's seat.
8. Insert the key (4) into the main switch on the control panel. Bring the main switch to its "I" position by turning the key (4) into the main switch clockwise (Fig.5).
9. Press the drive pedal (3) (Fig.3) to begin moving the machine.
10. Take the appliance to the designated machine storage place.

**! ATTENTION:** Park the machine in an enclosed place, on a flat surface, and at a safe distance from any objects that could either damage it or be damaged due to contact with the machine itself.

11. Secure the machine, see the section titled "SECURING THE MACHINE".

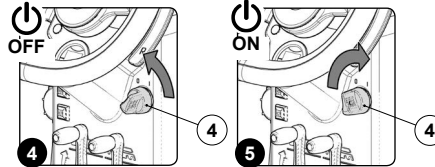

### 20. RECOMMENDED MAINTENANCE OPERATIONS

TYPE OF MAINTENANCE	AT THE END OF THE WORK	DAILY	WEEKLY	BEFORE A LONG PERIOD OF NON-USE	TRANSPORT
EMPTYING THE RECOVERY TANK	X			X	X
EMPTYING THE DEBRIS HOPPER (SWEEPING VERSION)	X			X	X
CLEANING THE SQUEEGEE BODY	X	X		X	
CLEANING THE BRUSH HEAD BRUSHES (SCRUBBING VERSION)		X		X	
CLEANING THE BRUSH HEAD BRUSHES (SWEEPING VERSION)		X		X	
CLEANING THE LATERAL BRUSH (SCRUBBING VERSION)		X		X	
CLEANING THE LATERAL BRUSH (SWEEPING VERSION)		X		X	
CLEANING THE RECOVERY TANK FILTERS		X		X	
CLEANING THE RECOVERY TANK		X		X	
CLEANING THE DEBRIS HOPPER (SWEEPING VERSION)	X			X	X
EMPTYING THE SOLUTION TANK		X		X	X
<sup>(1)</sup> RECHARGING THE BATTERIES		X			
CLEANING THE WATER SYSTEM FILTER		X		X	
CLEANING THE VACUUM TUBE		X		X	

Note:  
(1) In any event check the battery charge level when working.

## 1. EMPTYING THE RECOVERY TANK

Proceed as follows to empty the recovery tank:

1. Take the machine to the maintenance area.
2. Make sure the machine has been secured (see the section titled "SECURING THE MACHINE").

**CAUTION:** users are advised to always wear protective gloves, to avoid the risk of serious injury to hands.

3. Remove the drainage hose of the recovery tank from the clamps; it is located at the rear of the machine (Fig.1).
4. Bend the end of the drainage tube in order to create a choke and prevent the content from coming out (Fig.2), then position the tube on the discharge surface, unscrew the cap, and gradually release the tube.

**NOTE:** the place designated for this operation must comply with current environmental protection regulations.

5. Repeat the operations in reverse order to reassemble all the parts.

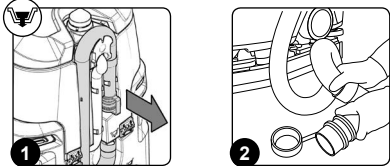

## 2. EMPTYING THE DEBRIS HOPPER (SWEEPING VERSION)

The thorough cleaning of the debris hopper ensures better floor cleaning performance. To clean the debris hopper, proceed as follows:

1. Take the machine to the maintenance area.
2. Make sure the machine has been secured (see the section titled "SECURING THE MACHINE").

**CAUTION:** these operations must be carried out using protective gloves to avoid any possible contact with the edges or tips of metal objects.

3. Open the machine's left lateral carter (1) (Fig.1).
4. Release the debris hopper locking pin (2) (Fig.2).
5. Use the handle (3) to extract the debris hopper (Fig.3) and empty it.

**NOTE:** the place designated for this operation must comply with current environmental protection regulations.

6. Clean the inside with a jet of water, and use a brush to remove any residual impurities if necessary.
7. Proceed in the opposite order to reassemble all the parts.

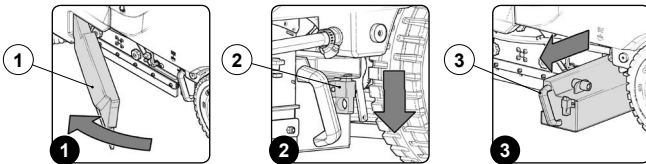

## 3. CLEANING THE SQUEEGEE BODY

The careful cleaning of the whole vacuum unit ensures better drying and cleaning of the floor as well as a longer vacuum motor life. To carry out the cleaning of the squeegee body, proceed as follows:

1. Take the machine to the maintenance area.
2. Make sure the machine has been secured (see the section titled "SECURING THE MACHINE").

**CAUTION:** these operations must be carried out using protective gloves to avoid any possible contact with the edges or tips of metal objects.

3. Extract the vacuum hose (1) from the vacuum nozzle on the squeegee body (Fig.1).
4. Completely unscrew the knobs (2) in the squeegee body's pre-assembly (Fig.2).
5. Remove the squeegee body from the slits in the squeegee connector (Fig.3).

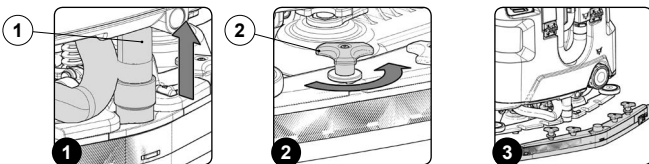

6. Thoroughly clean the squeegee body vacuum chamber (4) with a jet of water, and then with a damp cloth (Fig.4).

**NOTE:** the place designated for this operation must comply with current environmental protection regulations.

7. Thoroughly clean the squeegee body's rear rubber blade (5) with a jet of water, and then with a damp cloth (Fig.5).
8. Thoroughly clean the squeegee unit front rubber blade (6) with a jet of water, and then with a damp cloth (Fig.6).
9. Thoroughly clean the vacuum nozzle with a jet of water, and then with a damp cloth.
10. Proceed in the opposite order to reassemble all the parts.

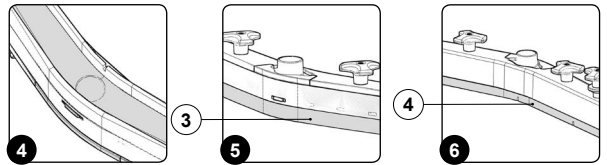

## 4. CLEANING THE BRUSH HEAD BRUSHES (SCRUBBING VERSION)

Careful cleaning of the brush guarantees better cleaning of the floor as well as a longer brush head gearmotor lifespan. To clean the brush, proceed as follows:

1. Take the machine to the maintenance area.
2. Make sure the machine has been secured (see the section titled "SECURING THE MACHINE").

**CAUTION:** these operations must be carried out using protective gloves to avoid any possible contact with the edges or tips of metal objects.

3. Open the machine's left lateral carter (1) (Fig.1).
4. Press the brush locking pin (1) (Fig.2).
5. Keeping the pin (2) pressed, turn the brush clockwise until it is released (Fig.3).
6. Turn until the button is pushed towards the outside of the coupling spring and is locked into place.
7. Clean the brush under a stream of running water to remove any impurities from its bristles. Check the wear status of the bristles and replace the brushes if they are excessively consumed (the bristles' protrusion must not be less than 10 mm; this distance is indicated on the brush by the yellow band). Read the paragraph "BRUSH HEAD BRUSHES REPLACEMENT (SCRUBBING VERSION)".
8. After checking to make sure that the brush is clean, reassemble it and move on to the one on the right hand side.

**NOTE:** you are advised to invert the right and left-hand brushes every day.

**NOTE:** Image 3 indicates the direction of rotation for coupling the left brush; the right brush must be turned in the opposite direction.

**ATTENTION:** If the brushes are not new however, and have deformed bristles, it is better to reassemble them in the same position (the right-hand one on the right, and the left-hand one on the left), to prevent the different inclination of the bristles producing an overload on the brush motor as well as excessive vibrations.

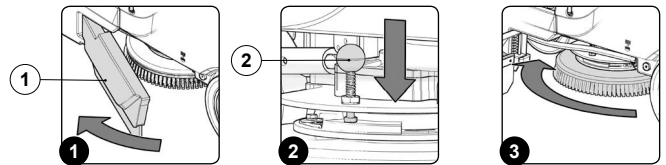

## 5. CLEANING THE BRUSH HEAD BRUSHES (SWEEPING VERSION)

Careful cleaning of the brush guarantees better cleaning of the floor as well as a longer brush head gearmotor lifespan. To clean the brush, proceed as follows:

1. Take the machine to the maintenance area.
2. Make sure the machine has been secured (see the section titled "SECURING THE MACHINE").

**CAUTION:** these operations must be carried out using protective gloves to avoid any possible contact with the edges or tips of metal objects.

3. Open the machine's left lateral carter (1) (Fig.1).
4. With the brush head in its raised position, turn the knobs (2) that hold the left lateral carter (3) in place anti-clockwise (Fig.2).
5. Remove the left lateral carter (3) (Fig.3).
6. Extract the brush from inside the tunnel (Fig.4). Clean the brush under a stream of running water to remove any impurities from its bristles. Check the bristles. If they are excessively worn, replace the brushes (the bristles should protrude by at least 10mm). Read the paragraph "BRUSH HEAD BRUSHES REPLACEMENT (SCRUBBING VERSION)" when replacing the brushes.
7. After checking to make sure that the brush is clean, reassemble it and move on to the one at the rear.

**NOTE:** you are advised to invert the right and left-hand brushes every day.

**ATTENTION:** If the brushes are not new, and have deformed bristles, it is better to reassemble them in the same position in order to prevent the different inclination of the bristles from overloading the brush motor, as well as to prevent excessive vibrations.

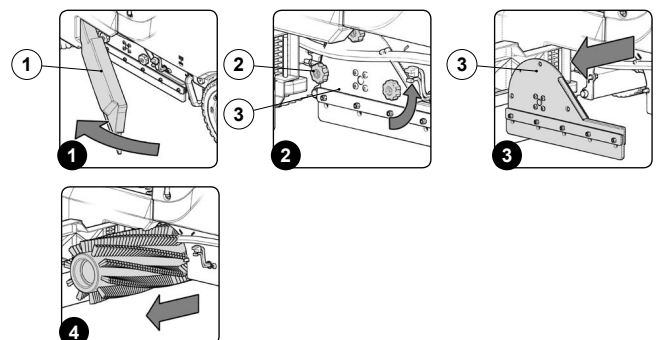



## 6. CLEANING THE LATERAL BRUSH (SCRUBBING VERSION)

Careful cleaning of the brush guarantees better cleaning of the floor as well as a longer brush head gearmotor lifespan. To clean the brush, proceed as follows:

1. Take the machine to the maintenance area.
  2. Make sure the machine has been secured (see the section titled "SECURING THE MACHINE").
- CAUTION:** these operations must be carried out using protective gloves to avoid any possible contact with the edges or tips of metal objects.
3. Open the machine's right lateral carter (1) (Fig.1).
  4. Move the brush release lever downwards (2) (Fig.2).
  5. Remove the brush from the lateral brush head (Fig.3).
  6. Clean the brush under a stream of running water to remove any impurities from its bristles. Check the bristles. If they are excessively worn, replace the brushes (the bristles should protrude by at least 10mm). Read paragraph "REPLACING LATERAL BRUSH 1SL (SCRUBBING VERSION)" to replace the brush.
  7. After checking to make sure that the brush is clean, reassemble it.

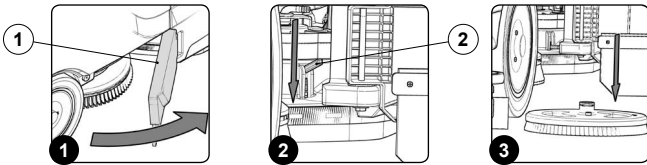

## 7. CLEANING THE LATERAL BRUSH (SWEEPING VERSION)

Careful cleaning of the brush guarantees better cleaning of the floor as well as a longer brush head gearmotor lifespan. To clean the brush, proceed as follows:

1. Sit on the driver's seat.
2. Insert the key (1) into the main switch on the control panel. Bring the main switch to its "I" position by turning the key (1) a quarter turn clockwise (Fig.1).
3. Check to make sure that the lateral brush head body is in its resting position, otherwise press the lateral brush control button (2) on the left-hand side of the steering column (Fig.2).
4. As soon as the brush head body has arrived in its resting position, perform the procedure for securing the machine (see the section titled "SECURING THE MACHINE").

**CAUTION:** these operations must be carried out using protective gloves to avoid any possible contact with the edges or tips of metal objects.

5. Stand on the right side of the machine.
6. With the brush head in its raised position, remove the knob (3) that secures the lateral brush to the gearmotor, by turning it clockwise for the right-hand brush, and anti-clockwise for the left-hand brush (Fig.3).
7. Remove the washer (4) holding the lateral brush in place (Fig.4).
8. Clean the brush under a stream of running water to remove any impurities from its bristles. Check the bristles. If they are excessively worn, replace the brushes (the bristles should protrude by at least 10mm). Read paragraph "REPLACING THE LATERAL BRUSH (SWEEPING VERSION)" to replace the brush.
9. After checking to make sure that the brush is clean, reassemble it and move on to the one on the left hand side.

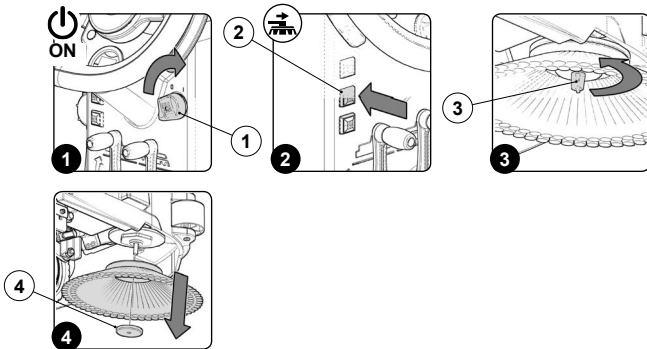

## 8. CLEANING THE RECOVERY TANK FILTERS

In order to clean the filters present inside the recovery tank, do the following:

1. Take the machine to the maintenance area.
2. Make sure the machine has been secured (see the section titled "SECURING THE MACHINE").

**CAUTION:** users are advised to always wear protective gloves, to avoid the risk of serious injury to hands.

**NOTE:** the place designated for this operation must comply with current environmental protection regulations.

3. Grip the handle (1) and raise the recovery tank's lid to its maintenance position (Fig.1).
4. Remove the dirty water basket/filter from the support (2) (Fig.2).
5. Remove the basket cover (3) from the basket/filter (2) (Fig.3).

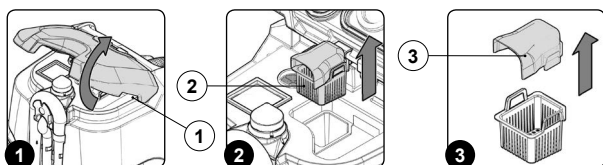

6. Clean the basket/filter (2) and the basket cover (3) under a jet of water.

**NOTE:** Use a spatula or brush to eliminate any dirt that is particularly difficult to remove.

7. Use a dry cloth to dry the basket/filter (2) and the basket cover (3) and place them back inside the recovery tank.
8. Remove the vacuum motor filter from the support (4) (Fig.4).
9. Extract the dirt present inside the vacuum motor's filter (4).

**NOTE:** Use a jet of water to eliminate any remaining dirt, and use a spatula or a brush with soft bristles to eliminate any dirt that is particularly hard to remove.

10. Wait for the vacuum motor's filter to dry, if necessary, and then place it back on its support.

**ATTENTION:** Wait for the filter to dry completely before using it again, or else use a spare.

11. Remove the vacuum motor's duct filter from its support (5) (Fig.5).
12. Clean the vacuum motor's duct filter under a jet of water (5).

**NOTE:** Use a spatula to eliminate any dirt that is particularly difficult to remove.

13. Dry the vacuum motor's duct filter with a dry cloth (5) and place it back on its support.
14. Clean the lower part of the vacuum cover with a damp cloth, and carefully clean the filter gaskets (Fig.6).
15. Grip the handle (1) and turn the recovery tank's cover to its working position.

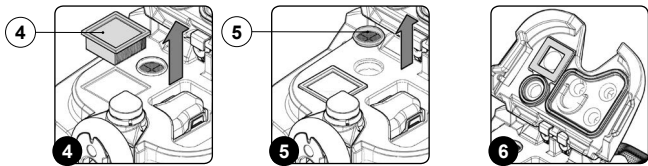

## 9. CLEANING THE RECOVERY TANK

Proceed as follows to empty the recovery tank:

1. Perform the procedure for emptying the recovery tank (see the section titled "EMPTYING THE RECOVERY TANK").
2. Make sure the machine has been secured (see the section titled "SECURING THE MACHINE").

**CAUTION:** users are advised to always wear protective gloves, to avoid the risk of serious injury to hands.

3. Once the recovery tank has been emptied, grip the handle (1) and raise the recovery tank's lid to its maintenance position (Fig.1).
4. Rinse the inside of the recovery tank with a jet of water. If necessary, use a spatula to remove any sludge that may have accumulated at the bottom of the tank.

**ATTENTION:** Be sure to also clean the electro-mechanical floats (2) present inside the tank (Fig.2).

5. Repeat the operations in reverse order to reassemble all the parts.

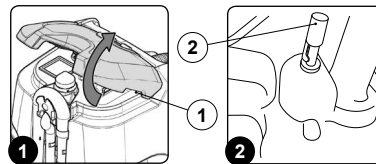

## 10. CLEANING THE DEBRIS HOPPER (SWEEPING VERSION)

The thorough cleaning of the debris hopper ensures better floor cleaning performance. To clean the debris hopper, proceed as follows:

1. Take the machine to the maintenance area.
2. Make sure the machine has been secured (see the section titled "SECURING THE MACHINE").

**CAUTION:** these operations must be carried out using protective gloves to avoid any possible contact with the edges or tips of metal objects.

3. Open the machine's left lateral carter (1) (Fig.1).
4. Release the debris hopper locking pin (2) (Fig.2).
5. Use the handle (3) to extract the debris hopper (Fig.3).

**NOTE:** the place designated for this operation must comply with current environmental protection regulations.

6. Clean the inside with a jet of water, and use a brush to remove any residual impurities if necessary.
7. Proceed in the opposite order to reassemble all the parts.

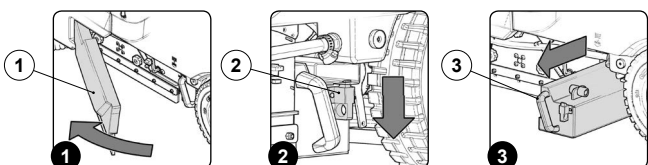

## 11. EMPTYING THE SOLUTION TANK

Proceed as follows to empty the solution tank:

1. Take the machine to the maintenance area.
2. Make sure the machine has been secured (see the section titled "SECURING THE MACHINE").

**CAUTION:** users are advised to always wear protective gloves, to avoid the risk of serious injury to hands.

1. Open the tap's output flow to maximum, and shift the knob on the left hand side of the steering column (1) (Fig.1) upward.
2. Unscrew the cap (2) for the solution tank dumping system (Fig.2); the cap is located at the rear of the machine.

**NOTE:** the place designated for this operation must comply with current environmental protection regulations.

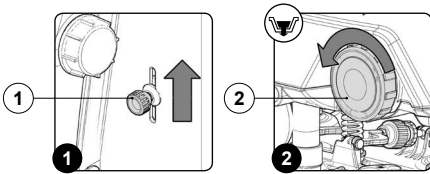

In order to clean the solution tank (versions without FLR), do the following:

1. Take the machine to the maintenance area.
2. Make sure the machine has been secured (see the section titled "SECURING THE MACHINE").

**CAUTION:** users are advised to always wear protective gloves, to avoid the risk of serious injury to hands.

1. Open the tap's output flow to maximum, and shift the knob on the left hand side of the steering column (1) (Fig.1) upward.
2. Unscrew the cap (2) for the solution tank dumping system (Fig.2); the cap is located at the rear of the machine.

**NOTE:** the place designated for this operation must comply with current environmental protection regulations.

3. Remove the cap/measuring device (3) (Fig.3), located on the left-hand side of the machine.
4. Rinse the inside of the solution tank with a jet of water
5. With the solution tank empty, repeat the operations in the reverse order to reassemble all the parts.

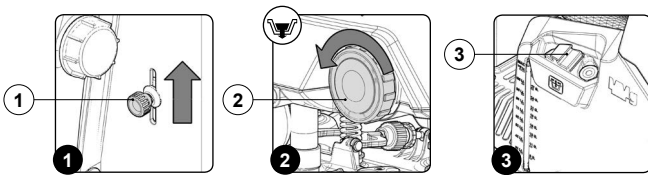

In order to clean the solution tank (versions with FLR), do the following:

1. Take the machine to the maintenance area.
2. Make sure the machine has been secured (see the section titled "SECURING THE MACHINE").

**CAUTION:** users are advised to always wear protective gloves, to avoid the risk of serious injury to hands.

1. Open the tap's output flow to maximum, and shift the knob on the left hand side of the steering column (1) (Fig.1) upward.
2. Unscrew the cap (2) for the solution tank dumping system (Fig.2); the cap is located at the rear of the machine.

**NOTE:** the place designated for this operation must comply with current environmental protection regulations.

3. Remove the cap/measuring device (3) (Fig.3), located on the left-hand side of the machine.

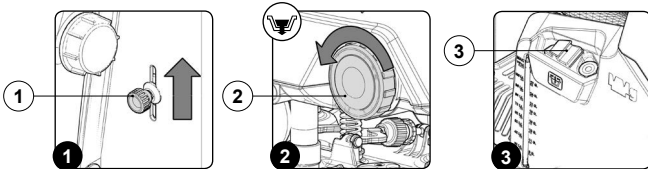

4. Grip the seat (4) and turn the seat's support plate to its maintenance position (Fig.4).
5. In order to prevent the seat's support plate from turning, insert the pin (5) into the slit (6) in the seat's support plate (Fig.5).
6. Unscrew the inspection cap (6) (Fig.6) located beneath the seat's support plate.
7. Rinse the inside of the solution tank with a jet of water.
8. Once the work has been completed, repeat the operations in reverse order to reassemble all the parts.

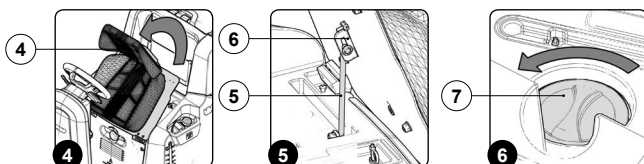

## 12. CLEANING THE WATER SYSTEM FILTER

In order to clean the water system's filter, do the following:

1. Take the machine to the maintenance area.
2. Make sure the machine has been secured (see the section titled "SECURING THE MACHINE").

**CAUTION:** users are advised to always wear protective gloves, to avoid the risk of serious injury to hands.

3. Close the tap's output flow, and shift the knob (1) on the left hand side of the steering column (Fig.1) downward.
4. Open the machine's left lateral hatch (2) (Fig.2).
5. Unscrew the detergent solution filter cap (3) (Fig.3).
6. Rinse the filter cartridge under a jet of water, and use a brush to eliminate any impurities, if necessary.

**NOTE:** the place designated for this operation must comply with current environmental protection regulations.

7. Once the filter cartridge is clean, repeat the operations in the opposite order to reassemble all the parts.

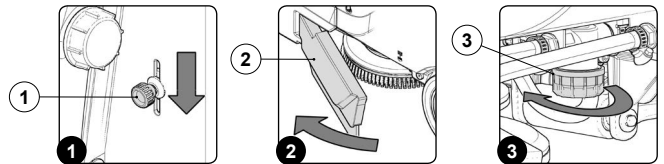

In order to clean the water system's filter on the FLR versions, do the following:

1. Take the machine to the maintenance area.
2. Make sure the machine has been secured (see the section titled "SECURING THE MACHINE").

**CAUTION:** users are advised to always wear protective gloves, to avoid the risk of serious injury to hands.

3. Close the tap's output flow, and shift the knob (1) on the left hand side of the steering column (Fig.1) downward.
4. Open the machine's left lateral hatch (2) (Fig.2).
5. Unscrew the detergent solution filter cap (3) (Fig.3).

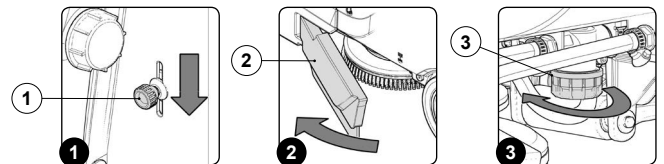

6. Rinse the filter cartridge under a jet of water, and use a brush to eliminate any impurities, if necessary.
7. Open the lateral hatch (4) (Fig.4) on the right-hand side of the machine.
8. Unscrew the cap (5) for the detergent solution recycling filter (Fig.5).
9. Rinse the filter cartridge under a jet of water, and use a brush to eliminate any impurities, if necessary.

**NOTE:** the place designated for this operation must comply with current environmental protection regulations.

10. Once the filter cartridges have been cleaned, repeat the operations in the reverse order to reassemble all the parts.

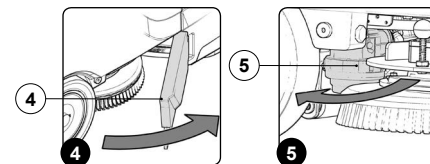

## 13. CLEANING THE VACUUM TUBE

Careful cleaning of the vacuum hose guarantees better cleaning of the floor as well as a longer vacuum motor life. Proceed as follows to clean the vacuum hose:

1. Take the machine to the maintenance area.
2. Make sure the machine has been secured (see the section titled "SECURING THE MACHINE").

**ATTENTION:** users are advised to always wear protective gloves, to avoid the risk of serious injury to hands.

3. Remove the vacuum hose (1) from the vacuum nozzle (2) on the squeegee unit (Fig.1).
4. Remove the vacuum tube (1) via the hole on the back of the recovery tank (Fig.2).
5. The vacuum hose from the retainers present inside the recovery tank.
6. Rinse the inside of the vacuum hose with a jet of running water.
7. Repeat the operations in reverse order to reassemble all the parts.

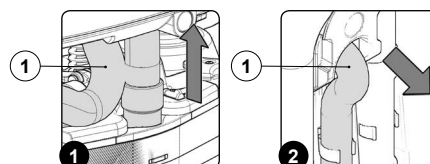

## 21. EXTRAORDINARY MAINTENANCE WORK

### 1. ASSEMBLING THE BRUSH HEAD BRUSHES (SCRUBBING VERSION)

To assemble the brushes to brush head body, which for reasons of packaging are supplied dismantled from the machine, proceed as follows:

1. Sit on the driver's seat.
2. Insert the key (1) into the main switch on the control panel. Bring the main switch to its "I" position by turning the key (1) a quarter turn to the right (Fig.1).
3. Turn the brush head control lever (2) anti-clockwise (Fig.2); in this manner the brush head's body will be raised off the floor.
4. As soon as the brush head body has arrived in its resting position, perform the procedure for securing the machine (see the section titled "SECURING THE MACHINE").

**CAUTION:** these operations must be carried out using protective gloves to avoid any possible contact with the edges or tips of metal objects.

5. Move to the left hand side of the machine and open the left lateral carter (3) (Fig.3).
6. With the brush head UP, insert the brush in the plate housing underneath the brush head, turning it until the three buttons engage with the niches on the plate itself.
7. Turn in increments until the button is pushed towards the coupling spring and is locked in place (Fig.4).

**NOTE:** Image 4 indicates the direction of rotation for coupling the left brush; the right brush must be turned in the opposite direction.

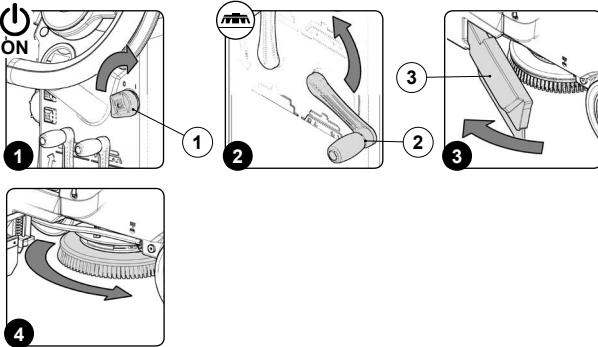

### 2. ASSEMBLING LATERAL BRUSH 1SL (SCRUBBING VERSION)

For packaging reasons, the lateral brush comes disassembled from the machine, and must be assembled on the brush head body by doing the following:

1. Sit on the driver's seat.
2. Insert the key (1) into the main switch on the control panel. Bring the main switch to its "I" position by turning the key (1) a quarter turn clockwise (Fig.1).
3. Check to make sure that the lateral brush head body is in its resting position, otherwise press the lateral brush control button (2) on the left-hand side of the steering column (Fig.2).
4. As soon as the brush head body has arrived in its resting position, perform the procedure for securing the machine (see the section titled "SECURING THE MACHINE").

**CAUTION:** these operations must be carried out using protective gloves to avoid any possible contact with the edges or tips of metal objects.

5. With the brush head in its resting position, insert the brush into the plate housing underneath the brush head, and turn it until the two buttons engage with the niches on the plate itself (Fig.3).
6. Push the brush until the stopper spring on the brush itself has engaged with the niche present on the gearmotor's pin.

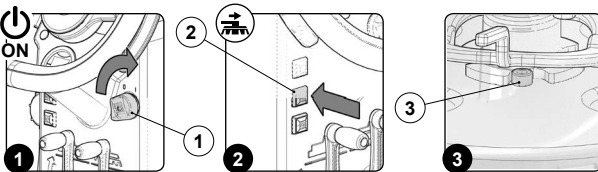

### 3. ASSEMBLING THE BRUSH HEAD BRUSHES (SWEEPING VERSION)

To assemble the brushes to brush head body, which for reasons of packaging are supplied dismantled from the machine, proceed as follows:

1. Sit on the driver's seat.
2. Insert the key (1) into the main switch on the control panel. Bring the main switch to its "I" position by turning the key (1) a quarter turn to the right (Fig.1).
3. Turn the brush head control lever (2) anti-clockwise (Fig.2); in this manner the brush head's body will be raised off the floor.
4. As soon as the brush head body has arrived in its resting position, perform the procedure for securing the machine (see the section titled "SECURING THE MACHINE").

**CAUTION:** these operations must be carried out using protective gloves to avoid any possible contact with the edges or tips of metal objects.

5. Open the machine's left lateral carter (3) (Fig.3).

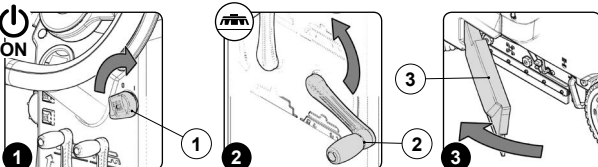

6. With the brush head in its resting position, turn the knobs (4) that hold the left lateral carter (5) in place anti-clockwise (Fig.4).
7. Remove the left lateral carter (5) (Fig.5).
8. Insert the brush into the tunnel (Fig.6), taking care to make sure that the gearmotor's drive shaft enters the slit in the brush itself.
9. Repeat the previously described operations for the right-hand side as well.

**NOTE:** In order to be installed correctly, the brushes must form an X when viewed from above in the forward direction of movement (Fig.7).

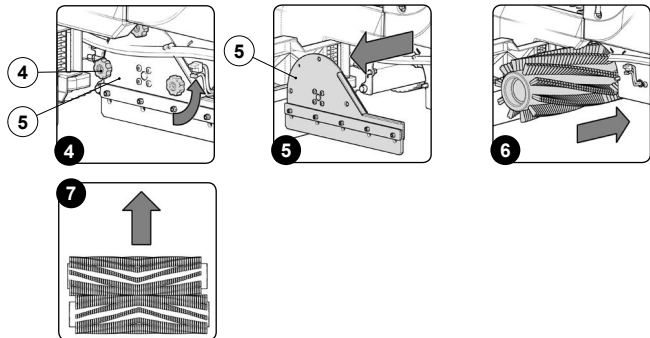

### 4. ASSEMBLING THE ABRASIVE PAD (ORBITAL VERSION)

For packaging reasons, the abrasive pad comes disassembled from the machine (if requested on the purchase order), and must be assembled on the brush head body by doing the following:

1. Sit on the driver's seat.
2. Insert the key (1) into the main switch on the control panel. Bring the main switch to its "I" position by turning the key (1) a quarter turn to the right (Fig.1).
3. Turn the brush head control lever (2) anti-clockwise (Fig.2); in this manner the brush head's body will be raised off the floor.
4. As soon as the brush head body has arrived in its resting position, perform the procedure for securing the machine (see the section titled "SECURING THE MACHINE").

**CAUTION:** these operations must be carried out using protective gloves to avoid any possible contact with the edges or tips of metal objects.

5. Move to the left hand side of the machine and open the left lateral carter (3) (Fig.3).
6. With the brush head in its raised position, insert the abrasive pad into the lodging present on the brush head body (Fig.4).

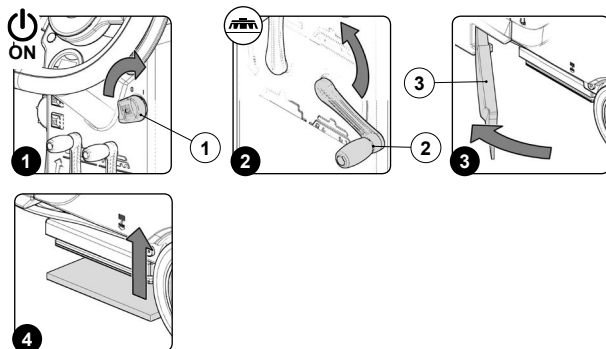

### 5. REPLACING THE BRUSH HEAD BRUSHES (SCRUBBING VERSION)

Ensuring the integrity of the brush will guarantee better floor cleaning results, and will extend the service life of the brush head's gearmotor. To clean the brush, proceed as follows:

1. Take the machine to the maintenance area.
2. Make sure the machine has been secured (see the section titled "SECURING THE MACHINE").

**CAUTION:** these operations must be carried out using protective gloves to avoid any possible contact with the edges or tips of metal objects.

3. Move to the left hand side of the machine and open the left lateral carter (1) (Fig.1).
4. Press the brush locking pin (1) (Fig.2).
5. Keeping the pin (2) pressed, turn the brush (3) clockwise until it is locked in place (Fig.3).
6. Turn until the button is pushed towards the outside of the coupling spring and is locked into place.
7. Replace the worn brush with the new one. In order to insert the brush into the brush housing plate, see the section titled "ASSEMBLING THE BRUSH HEAD BRUSHES (SCRUBBING VERSION)".

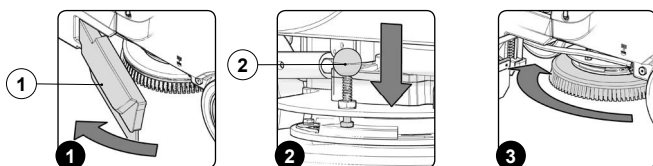



**6. REPLACING THE BRUSH HEAD BRUSHES (SWEEPING VERSION)**

Ensuring the integrity of the brush will guarantee better floor cleaning results, and will extend the service life of the brush head's gearmotor. To clean the brush, proceed as follows:

1. Take the machine to the maintenance area.
2. Make sure the machine has been secured (see the section titled "SECURING THE MACHINE").
- CAUTION:** these operations must be carried out using protective gloves to avoid any possible contact with the edges or tips of metal objects.
3. Move to the left hand side of the machine and open the left lateral carter (1) (Fig.1).
4. With the brush head in its raised position, turn the knobs (2) that hold the left lateral carter (3) in place anti-clockwise (Fig.2).
5. Remove the left lateral carter (3) (Fig.3).
6. Extract the brush from inside the tunnel (Fig.4). Read paragraph "INSTALLING THE BRUSH HEAD BRUSHES (SWEEPING VERSION)" when replacing the brushes.
7. Once the brush has been replaced, move on to the one at the rear.

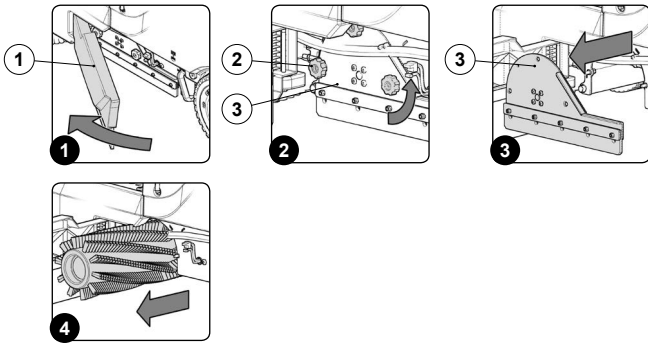

**7. REPLACING LATERAL BRUSH 1SL (SCRUBBING VERSION)**

Ensuring the integrity of the brush will guarantee better floor cleaning results, and will extend the service life of the brush head's gearmotor. To clean the brush, proceed as follows:

1. Take the machine to the maintenance area.
2. Make sure the machine has been secured (see the section titled "SECURING THE MACHINE").
- CAUTION:** these operations must be carried out using protective gloves to avoid any possible contact with the edges or tips of metal objects.
3. Move to the right-hand side of the machine and open the right lateral carter (1) (Fig.1).
4. Move the brush release lever downwards (2) (Fig.2).
5. Remove the brush from the lateral brush head (Fig.3).
6. Replace the worn brush with the new one. In order to insert the brush into the brush housing plate, see the section titled "ASSEMBLING LATERAL BRUSH 1SL (SCRUBBING VERSION)".

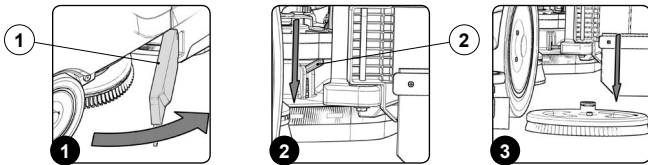

**8. REPLACING THE LATERAL BRUSH (SWEEPING VERSION)**

Ensuring the integrity of the brush will guarantee better floor cleaning results, and will extend the service life of the brush head's gearmotor. To clean the brush, proceed as follows:

1. Sit on the driver's seat.
2. Insert the key into the main switch on the control panel. Turn the main machine switch to its "I" position by turning the key a quarter turn to the right.
3. Check to make sure that the lateral brush head body is in its resting position, otherwise press the lateral brush control button (1) on the left-hand side of the steering column (Fig.1).
4. As soon as the brush head body has arrived in its resting position, perform the procedure for securing the machine (see the section titled "SECURING THE MACHINE").

**CAUTION:** these operations must be carried out using protective gloves to avoid any possible contact with the edges or tips of metal objects.

5. Stand on the right side of the machine.
6. With the brush head in its raised position, remove the knob (2) that secures the lateral brush to the gearmotor, by turning it clockwise for the right-hand brush, and anti-clockwise for the left-hand brush (Fig.2).
7. Remove the washer (3) holding the lateral brush in place (Fig.3).
8. Clean the brush under a stream of running water to remove any impurities from its bristles. Check the bristles are not worn; in the event of excessive wear, replace the brushes. Read paragraph "ASSEMBLING THE LATERAL BRUSH (SWEEPING VERSION)" when replacing the brushes.
9. After checking to make sure that the brush is clean, reassemble it and move on to the one on the left hand side.

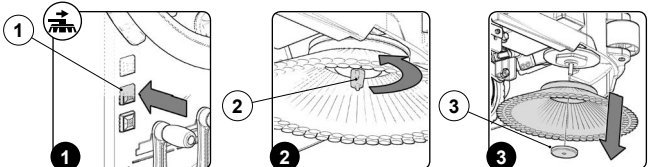

**9. REPLACING THE ABRASIVE PAD**

Ensuring the good condition of the abrasive pad will guarantee better floor cleaning results, and will extend the service life of the brush head's gearmotor. In order to replace the pad, do the following:

1. Take the machine to the maintenance area.
2. Make sure the machine has been secured (see the section titled "SECURING THE MACHINE").
- CAUTION:** these operations must be carried out using protective gloves to avoid any possible contact with the edges or tips of metal objects.
3. Move to the left hand side of the machine and open the left lateral carter (1) (Fig.1).
4. Shift the worn pad downwards (Fig.2).
5. Replace the worn pad with the new one. In order to insert the pad into the housing on the brush head body, see the section titled "ASSEMBLING THE ABRASIVE PAD (ORBITAL VERSION)".

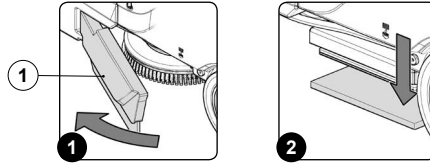

**10. REPLACING THE SQUEEGEE UNIT RUBBER BLADES**

Ensuring the integrity of the squeegee body's rubber blades guarantees better floor cleaning and drying results, as well as a longer service life for the vacuum motor. In order to replace the squeegee body's rubber blades, do the following:

1. Take the machine to the maintenance area.
2. Make sure the machine has been secured (see the section titled "SECURING THE MACHINE").
- CAUTION:** these operations must be carried out using protective gloves to avoid any possible contact with the edges or tips of metal objects.
3. Extract the vacuum hose (1) from the vacuum nozzle on the squeegee body (Fig.1).
4. Completely unscrew the knobs (2) in the squeegee body's pre-assembly (Fig.2).
5. Remove the squeegee body from the slits in the squeegee connector (Fig.3).

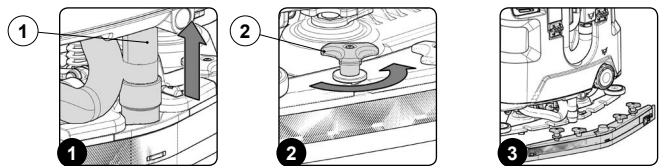

6. Remove the rear rubber blade compression plate, and release the stopper (3) at the rear of the squeegee (Fig.4).
7. Remove the rear rubber blade (4) from the squeegee body (Fig.5).
8. Completely unscrew the knobs (5) in the squeegee body's pre-assembly (Fig.6).

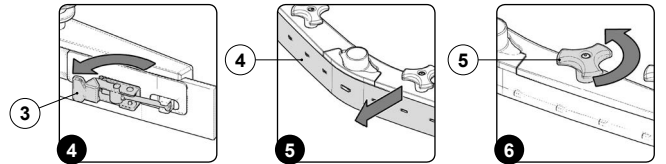

9. Remove the front rubber blade (6) from the squeegee's internal body (Fig.7).
10. Repeat the operations in reverse order to reassemble all the parts.

**NOTE:** Before using the machine, remember to adjust the squeegee body: see the section titled "ADJUSTING THE SQUEEGEE BODY'S RUBBER BLADES".

**NOTE:** It is recommended to replace both squeegee body blades in order to ensure good results when drying the floor.

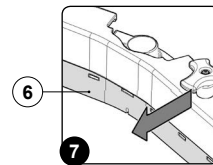

**22. DISPOSAL**

To dispose of the machine, take it to a demolition centre or an authorised collection centre.

Before scrapping the machine, it is necessary to remove and separate out the following materials, then send them to the appropriate collection centres in accordance with the environmental hygiene regulations currently in force:

- Brushes
- Felt
- Electric and electronic parts\*
- Batteries
- Plastic parts (tanks and handlebars)
- Metal parts (levers and frame)

(\* In particular, contact your distributor when scrapping electric and electronic parts.

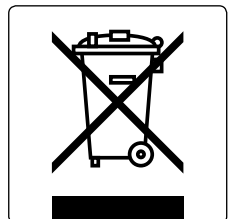



## 23. ADJUSTMENT INTERVENTIONS

### ADJUSTING THE SQUEEGEE BODY'S RUBBER BLADES

The careful adjustment of the squeegee unit rubber blades guarantees better cleaning of the floor. To adjust the squeegee blades, proceed as follows:

1. Sit on the driver's seat.
2. Insert the key (1) into the main switch on the control panel. Bring the main switch to its "I" position by turning the key (1) a quarter turn clockwise (Fig.1).
3. Turn the squeegee control lever (2) anti-clockwise (Fig.2) to bring the squeegee body to its working position.
4. Press the drive pedal (3) (Fig.3) to begin moving the machine.
5. As soon as the brush head and the squeegee have reached their working positions, perform the procedure for securing the machine (see the section titled "SECURING THE MACHINE").

**ATTENTION:** these operations must be carried out using protective gloves to avoid any possible contact with the edges or tips of metal objects.

6. Stand at the back of the machine.  
**Adjusting the height of the squeegee body:**

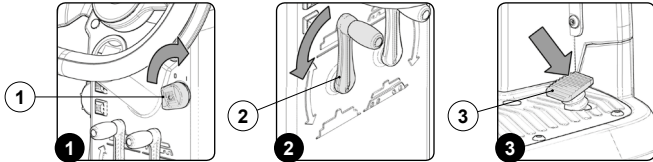

7. Release the stopper lever (4) for the squeegee's height adjustment knob (5) (Fig.4).
8. Adjust the height of the rubber blade in relation to the floor by loosening or tightening the knobs (5) (Fig.5).
  - NOTE:** Figure 5 indicates the direction of rotation for decreasing the distance between the squeegee support and the floor. This distance can be increased by turning it in the opposite direction.
  - NOTE:** By decreasing the distance between the squeegee support and the floor, the rubber blades present in the squeegee's body move closer to the floor.
  - NOTE:** the right-hand and left-hand knobs must be rotated the same number of times, so that the squeegee is parallel to the floor when it is working.
  - NOTE:** Check for proper adjustment by looking at the instrument (6) positioned on the squeegee body (Fig.6).
9. Once the adjustment has been completed, engage the stopper lever (4) (Fig.7).

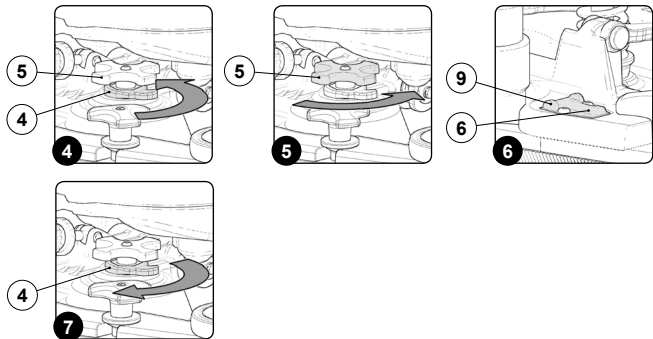

### Adjusting the tilt of the squeegee body:

10. Loosen the stopper knob (7) for the squeegee's tilt adjustment knob (8) (Fig.8).
11. In order to adjust the tilt of the squeegee body's rubber blades in relation to the floor, tighten or loosen the knob (8) until the squeegee body's rubber blades are bent outwards by about 30° in relation to the floor, in an even manner along their entire length (Fig.9).
  - NOTE:** Figure 9 indicates the direction of rotation for tilting the squeegee towards the rear of the machine (Fig.10). Turn it in the opposite direction to rotate the squeegee towards the front of the machine.
  - NOTE:** Check for proper adjustment by looking at the instrument (9) positioned on the squeegee body (Fig.6).
12. Once the adjustment has been completed, tighten the stopper knob (7) (Fig.11).

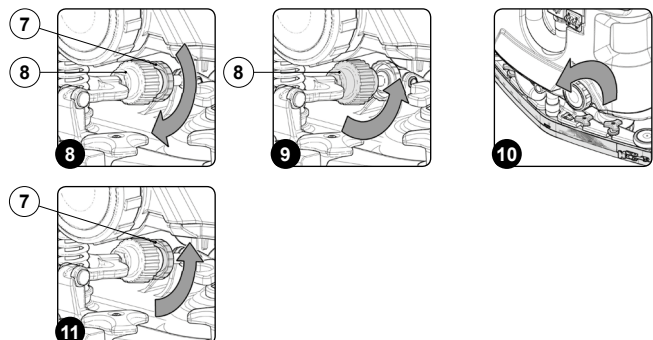

## 24. EC DECLARATION OF CONFORMITY



The undersigned manufacturer:

**FIMAP S.p.A.**

Via Invalidi del Lavoro, 1  
37059 Santa Maria di Zevio (VR)

declares under its sole responsibility that the products

### FLOOR SCRUBBING MACHINES

mod. MMg base CB - MMg base 1SL CB - MMg cylindrical CB - MMg orbital CB

comply with the requirements of the following Directives:

- 2006/42/EC: Machinery Directive.
- 2014/35/EC: Low Voltage Directive.
- 2014/30/EC: Electromagnetic compatibility directive.

They also comply with the following standards:

- EN 60335-1: Household and similar electrical appliances - Safety. Part 1: Generic standards.
- EN 60335-2-72: Household and similar electrical appliances. Part 2: Specific standards for automatic machines for floor treatment for commercial and industrial use.
- EN 60335-2-29: Household and similar electrical appliances. Part 2: Special standards for battery chargers.
- EN 12100-1: Safety of Machinery - Basic concepts, general principles for design - Part 1: Basic terminology and methodology.
- EN 12100-2: Safety of Machinery - Basic concepts, general principles for design - Part 2: Technical principles.
- EN 61000-6-2: Electromagnetic compatibility (EMC) - Part 6-2: Generic standards - Immunity for industrial environments.
- EN 61000-6-3: Electromagnetic compatibility (EMC) - Part 6-3: Generic standards - Standard emission for residential, commercial and light-industrial environments.
- EN 61000-3-2: Electromagnetic compatibility (EMC) - Part 3-2: Limits - Limits for harmonic current emissions (Equipment with input current ≤ 16 A per phase).
- EN 61000-3-3: Electromagnetic compatibility (EMC) - Part 3-3: Limits - Restriction of voltage variations and flicker in low voltage power supply systems for devices with a rated current ≤ 16 A.
- EN 55014-1: Electromagnetic compatibility - Regulations for household appliances, electrical devices and similar equipment. Part 1: Emission - Regulation for product family.
- EN 55014-2: Electromagnetic compatibility - Regulations for household appliances, electrical devices and similar equipment. Part 2: Immunity - Regulation for product family.
- EN 62233: Household and similar electrical appliances - Electromagnetic fields - Methods for evaluation and measurement.

The person authorized to compile the technical file:

Mr. Giancarlo Ruffo  
Via Invalidi del Lavoro, 1  
37059 Santa Maria di Zevio (VR) - ITALY

Santa Maria di Zevio (VR), 11/07/2016

Fimap S.p.A.  
Legal representative  
Giancarlo Ruffo

The undersigned manufacturer:

**FIMAP S.p.A.**

Via Invalidi del Lavoro, 1  
37059 Santa Maria di Zevio (VR)

declares under its sole responsibility that the products

### FLOOR SCRUBBING MACHINES

mod. MMg base - MMg base 1SL - MMg cylindrical - MMg orbital

comply with the requirements of the following Directives:

- 2006/42/EC: Machinery Directive.
- 2014/30/EC: Electromagnetic compatibility directive.

They also comply with the following standards:

- EN 60335-1: Household and similar electrical appliances - Safety. Part 1: Generic standards.
- EN 60335-2-72: Household and similar electrical appliances. Part 2: Specific standards for automatic machines for floor treatment for commercial and industrial use.
- EN 12100-1: Safety of Machinery - Basic concepts, general principles for design - Part 1: Basic terminology and methodology.
- EN 12100-2: Safety of Machinery - Basic concepts, general principles for design - Part 2: Technical principles.
- EN 61000-6-2: Electromagnetic compatibility (EMC) - Part 6-2: Generic standards - Immunity for industrial environments.
- EN 61000-6-3: Electromagnetic compatibility (EMC) - Part 6-3: Generic standards - Standard emission for residential, commercial and light-industrial environments.
- EN 62233: Household and similar electrical appliances - Electromagnetic fields - Methods for evaluation and measurement.

The person authorized to compile the technical file:

Mr. Giancarlo Ruffo  
Via Invalidi del Lavoro, 1  
37059 Santa Maria di Zevio (VR) - ITALY

Santa Maria di Zevio (VR), 11/07/2016

Fimap S.p.A.  
Legal representative  
Giancarlo Ruffo

## 25. TROUBLESHOOTING

This chapter lists the most common problems linked with the use of the machine. If you are unable to resolve the problems with the information given here, please contact your nearest assistance centre.

PROBLEM	POSSIBLE CAUSE	SOLUTION
THE MACHINE DOES NOT START	The main switch is set to "0".	Make sure that the main switch is in its "I" position, otherwise turn the key a quarter turn clockwise.
	Check that when switched on there are no alarm messages on the control display.	Stop the machine immediately, and contact a specialised service centre.
	Make sure that the batteries are correctly connected to each other and that the battery connector is connected to the electrical system connector.	Make sure that the batteries are properly connected inside the machine (see the section titled <a href="#">INSERTING THE BATTERIES INTO THE MACHINE</a> ).
	Check the charge level of the batteries.	If the battery charge level is critical, perform a complete recharge cycle (see paragraph <a href="#">CHARGING THE BATTERIES</a> ).
THE BATTERIES ARE NOT CHARGED CORRECTLY (VERSIONS WITHOUT AN ON BOARD BATTERY CHARGER)	The connector of the battery charger cable is not properly inserted in the battery connector.	Connect the battery charger cable connector to the battery connector again.
	The plug on the battery charger's power cable is not correctly inserted into the electrical outlet.	Check that the battery charger power supply cable plug is connected to the mains socket.
	The characteristics of the mains power supply do not correspond to those required by the battery charger.	Check that the characteristics in the battery charger plate are the same as those of the mains supply.
	The LEDs of the battery charger blink repeatedly.	Referring to the battery charger use and maintenance manual, check the meaning of the flashing signals that the battery charger emits during the battery recharge stage.
THE BATTERIES ARE NOT CHARGED CORRECTLY (VERSIONS WITH AN ON BOARD BATTERY CHARGER)	The plug on the battery charger's cable is not correctly inserted into the socket on the battery charger itself.	Reconnect the battery charger's power cable.
	The plug on the battery charger's power cable is not correctly inserted into the electrical outlet.	Check that the battery charger power supply cable plug is connected to the mains socket.
	The characteristics of the mains power supply do not correspond to those required by the battery charger.	Check that the characteristics in the battery charger plate are the same as those of the mains supply.
	The LEDs of the battery charger blink repeatedly.	Referring to the battery charger use and maintenance manual, check the meaning of the flashing signals that the battery charger emits during the battery recharge stage.
THE MACHINE HAS A VERY LOW WORK AUTONOMY	Check the battery charge level, check the symbol on the control display.	If the battery charge level is critical, perform a complete recharge cycle (see paragraph <a href="#">CHARGING THE BATTERIES</a> ).
THE MACHINE DOES NOT MOVE	The machine does not start.	Read the section " <a href="#">THE MACHINE DOES NOT START</a> ".
	There is an issue on the drive pedal.	Contact your nearest service centre.
INSUFFICIENT DETERGENT SOLUTION ON THE BRUSHES	The quantity of detergent solution in the water system is not sufficient for the work to be carried out.	Check that the amount of detergent solution present in the machine's water system is sufficient for the work to be carried out.
	Detergent solution filter obstructed.	Check that the detergent solution filter is not obstructed; if it is, clean it (read " <a href="#">CLEANING THE DETERGENT SOLUTION FILTER</a> ").
THE MACHINE DOES NOT CLEAN CORRECTLY	The machine does not start.	Read the section " <a href="#">THE MACHINE DOES NOT START</a> ".
	Not enough detergent solution comes out.	Read the section " <a href="#">INSUFFICIENT DETERGENT SOLUTION ON THE BRUSHES</a> ".
	The brushes have not been inserted correctly in the machine.	Check that the disc brushes have been correctly inserted into the machine (see the section titled " <a href="#">ASSEMBLING THE BRUSH</a> ").
	The type of brush used is not suitable for the dirt to be cleaned.	Make sure that the brushes fitted on the machine are suitable for the work to be carried out. Read " <a href="#">CHOOSING AND USING THE BRUSHES</a> ".
THE SQUEEGEE DOES NOT DRY PERFECTLY	The vacuum unit is obstructed.	Make sure the squeegee is free of obstructions (read " <a href="#">CLEANING THE SQUEEGEE BODY</a> ").
		Make sure the vacuum tube is free of obstructions (read " <a href="#">CLEANING THE SQUEEGEE BODY VACUUM TUBE</a> ").
		Make sure that the vacuum cap filter is free of any obstructions (see the section titled " <a href="#">CLEANING THE RECOVERY TANK'S FILTER</a> ").
		Make sure the vacuum motor filter is free of obstructions (read " <a href="#">CLEANING THE VACUUM MOTOR FILTER</a> ").
	The cap on the recovery tank drainage tube is not properly positioned.	Check that the cap on the recovery tank drainage tube is positioned properly.
The recovery tank lid is not positioned correctly.	Check that the recovery tank lid is properly positioned on the machine.	
EXCESSIVE FOAM PRODUCTION	The detergent being used is not suitable.	Check that a low foam detergent has been used. If necessary, add a small quantity of antifoam liquid to the recovery tank.
	The floor is not very dirty.	Dilute the detergent more.
THE MACHINE DOES NOT VACUUM CORRECTLY	The recovery tank is full.	Empty the recovery tank (read " <a href="#">EMPTYING THE RECOVERY TANK</a> ").
	The vacuum device is obstructed	Read the section " <a href="#">THE SQUEEGEE DOES NOT DRY PERFECTLY</a> ".

**NOTES**

A large rectangular area with a light gray background and horizontal lines, intended for taking notes.







FIMAP S.p.A. - Via Invalidi del Lavoro, 1 - 37059 S. Maria di Zevio - Verona - Italy  
Tel. +39 045 6060411 – Fax +39 045 6060417 – E-mail:[fimap@fimap.com](mailto:fimap@fimap.com)  
[www.fimap.com](http://www.fimap.com)