

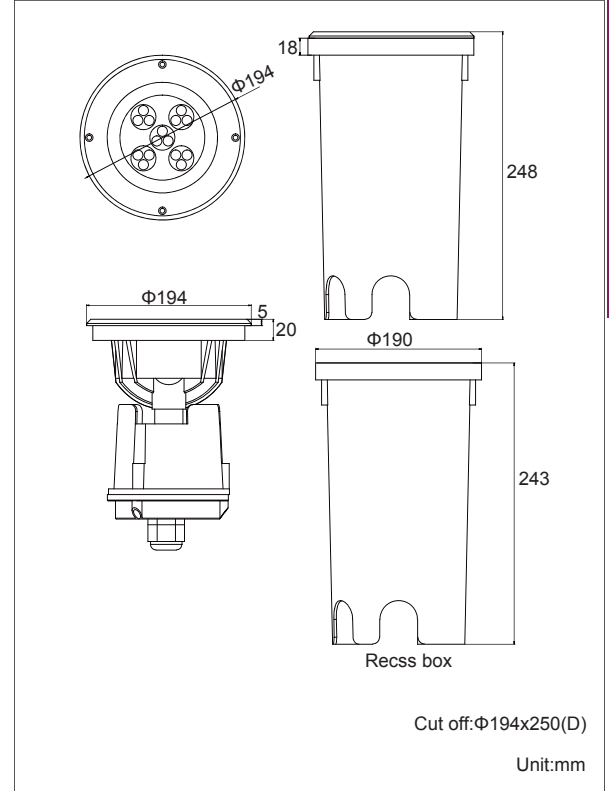

## Product Dimensions:

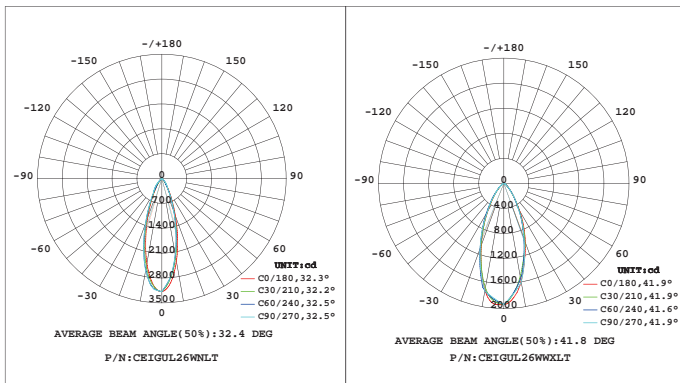

## Luminous Intensity Distribution Diagram:



## Lux Distribution:

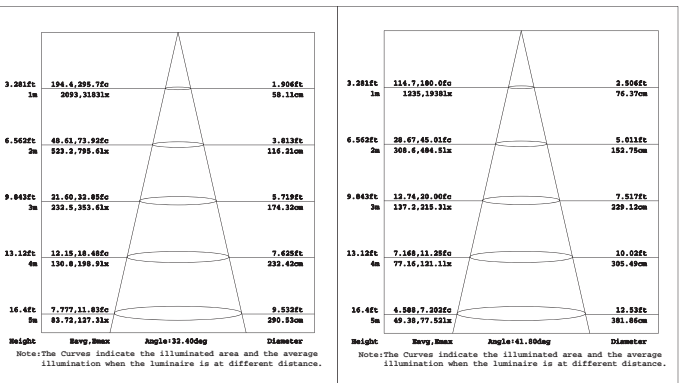

### Manufacturing Quality Standard:

- ISO 9001:2008

### LED Luminaire Standard:

- EN/IEC 60598-1
- EN/IEC 60598-2-1
- EN/IEC 60598-2-2
- EN/IEC 60529
- EN/IEC 62471-2
- IEC 62612
- EN/IEC 60968
- IEC 62560
- EN/IEC 60061-1
- EN 13032-1
- EN 13032-2
- EN/IEC 62471
- EN/IEC 60825
- EN 60061-1

### Electronic Driver Standard:

- EN/IEC 61347-1
- EN/IEC 61347-2-13
- EN/IEC 62384
- EN/IEC 61000-3-2
- EN/IEC 61000-3-3
- EN/IEC 61547
- EN 55015(CISPR 15)

### LED Module Standard:

- IEC 62031
- IEC 60838-2-2

### RoHS Standard:

- EPA3050B
- EN 1122B
- IEC 62321
- EPA3052
- EPA3060A
- EPA7196A
- EPA3540C
- EPA8270D

### LED Light Photometric Standard:

- CIE; TM14; LM-75; IES; LDT; CEN; CIB

### LED Luminaire Performance:

- LM-80-08
- Switching cycle:100,000x

## Features:

- Excellent design in waterproof IP67
- 316# standard stainless steel frame and fastness part
- High-pure die cast aluminum body with electrostatic powder coating
- 8mm thickness tempered glass
- Silicon seal gasket
- PMMA optical level lens for light distribution
- Integral IP65 constant current power supply
- The power supply housing and LED is designed separately, good for maintenance
- With several kinds of beam angle
- With high shock bear ability, the tempered glass can bear 10,000 N force.

## Applications:

- Road
- Sculpture
- Walkway
- Park
- Clump
- Bridge



## Specifications:

Power	26W
Input Voltage	AC 100~240V 50/60Hz
Beam Angle	10° / 17° / 33° / 45°
Color Rendering Index	80
Luminaire Efficacy	* 49lm/w (3000K), * 52lm/w (4000K), * 56lm/w (5000K), * 63lm/w (6500K)
LED Source Efficacy	* 100lm/w (3000K), * 110lm/w (4000K), * 120lm/w (5000K), * 120lm/w (6500K)
Safety Type	II
Operating Temperature	-20~50°C
Operating Humidity	0~95%RH
LED Source	CREE
Life Time	50,000 Hours at Ta=40°C
Housing Materials	316# Stainless Steel / Tempered Glass
Body Color	Steel Silver
Net Weight	3.28kg

## Ordering Part No.:

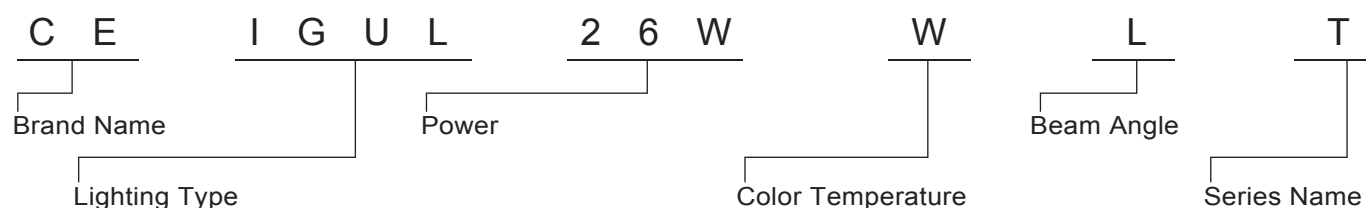

Brand Name	Lighting Type	Power	Color Temperature	Beam Angle	Series Name
CE: CELEX	IGUL: In-Ground Up-Light	26W	W: 3000K N: 4000K D: 5000K C: 6500K	S: 10° M: 17° L: 33° X: 45°	T: TONE Series

## Installation Guide:

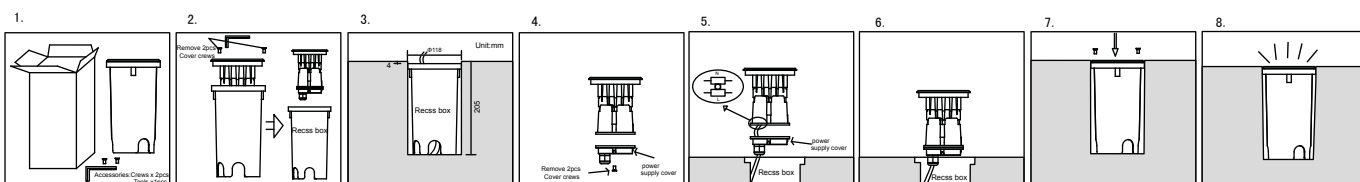

## LED In-ground Lighting

### Note:

1. This lighting should be installed according to the instruction leaflet, please keep it well.
2. This instruction leaflet is suitable for In-ground lighting. Before installing, please check carefully with label of the light. The specification please see the.

### Attention:

When installation, please conform to the instruction of equipment, and installed by professionals.

### Features:

1. The body of this light is made of High-pure die cast aluminum ZL102; the surface is finished with electrostatic powder coating, thermostatic hardening.
2. With novel design and compact structure, using aluminum board matching the SMD LED, the board contacts the body directly, with well twice heat radiation structure, which helps the light reach the lifetime of 50,000 hours.
3. The driver housing and light source housing is designed separately. The advantage: Forbidden heat composition, supply effective cooling, and good for maintenance.
4. The safety class is IP 67
5. LED Adopt three to one mode, supply cool white, warm white, RGB, panel light source. It is original Cree packed.
6. With several kinds of angles (10°/17°/33°/45°) for choosing, lens can be changeable, which can satisfy your different kind of needs.
7. With high shark bear ability, the glass can bear 20KN force. It is suitable for every place.
8. If there is any broken on the surface or glasses please do not use it.

### Application field:

This light can be used in the place of street, park, clump, playground, dock, bridge, billboard, on the wall of high building and other lighting places.

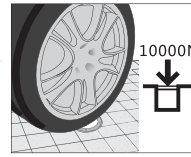

### Product Size

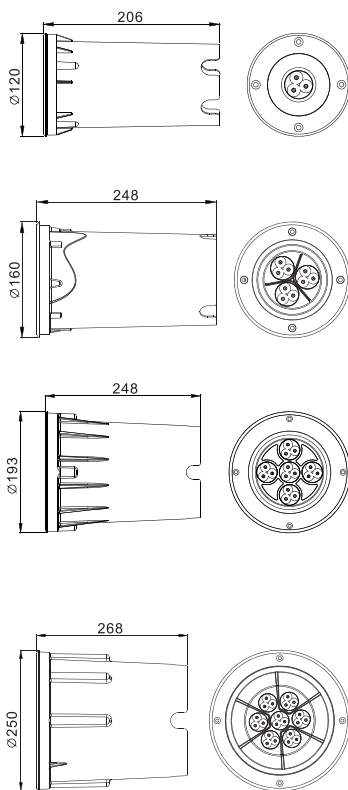

### Packing accessories :

M5 wrench ring spanner instruction

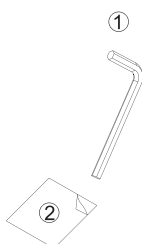

### Installation Requirements

1. The installing surface should put some sand; in order to let the water around can permeate to the ground.

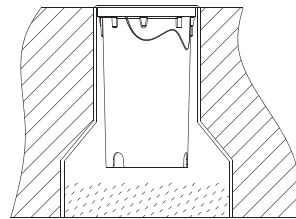

2. The Led In-ground Light should with good drainage system, avoiding the light is sunk by the water.

⚠ The light should not be soaked in the water for a long time.

### Install prerequisite

1. Switch off the mains or respectively the connection lead before doing any works.

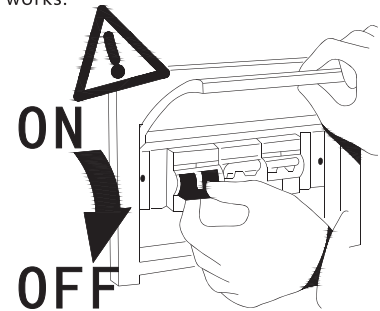

- ⚠ Before installing, turn off the power
- ⚠ Be sure all the cable boxes and power, plug installed fasten, and upright.
- ⚠ The model, rated voltage, rated wattage and other parameters should be the same with the design parameters.
- ⚠ The electrician should be the professional.
- ⚠ When installing, please sure of the good drainage system, and not sunk by the water.
- ⚠ After the light is connected with the power, fasten the cable box with the original, fasten the cable hole.

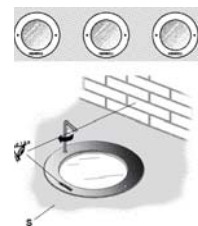

- ⚠ A Please make sure that upon the area "s", there is no projections.
- ⓐ B Logo should face the eyesight.

## Choose the suitable installing way

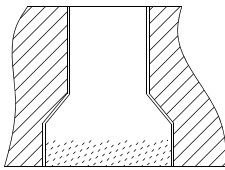

Hole sides

- Diameter 118mm
- Diameter 155mm
- Diameter 190mm
- Diameter 245mm

### ⚠ Attention:

This light can change the installing way according to the different requirement. The heat discharge groove should not be covered by the heat discharge groove.

## Installing steps

1. Inspect the light

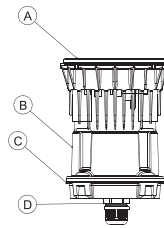

- (A) Check the glass broken or not;
- (B) Check the body of the lamp;
- (C) Check the cushion ring fasten well or not;
- (D) Once found anything not good, please change it or improve it.

⚠ If there is anything in bad condition, please change it in time then improve it.

2. Installing Light, screw the panel screw.

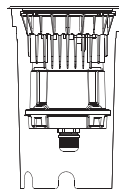

⚠ Be sure of the surface of the glass clean, no dust or any other bad appearance.

3. Please connect with the power with the cable connecting marking. The cable connecting instruction of the high voltage of the products:

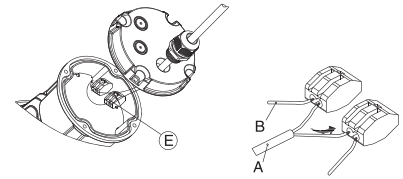

Suitable for single connecting, A power cable, B driver cable

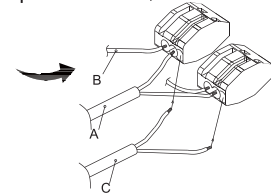

Suitable for one in one out: A power cable (in) B driver cable C power cable (out)

⚠ Lead L in brown, N in blue, insert it into groove.

## Cable connection instruction

Cable connecting procedure

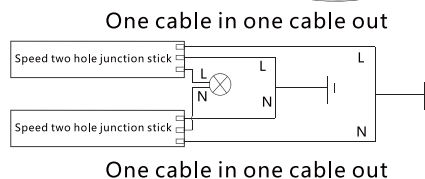
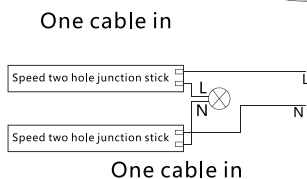
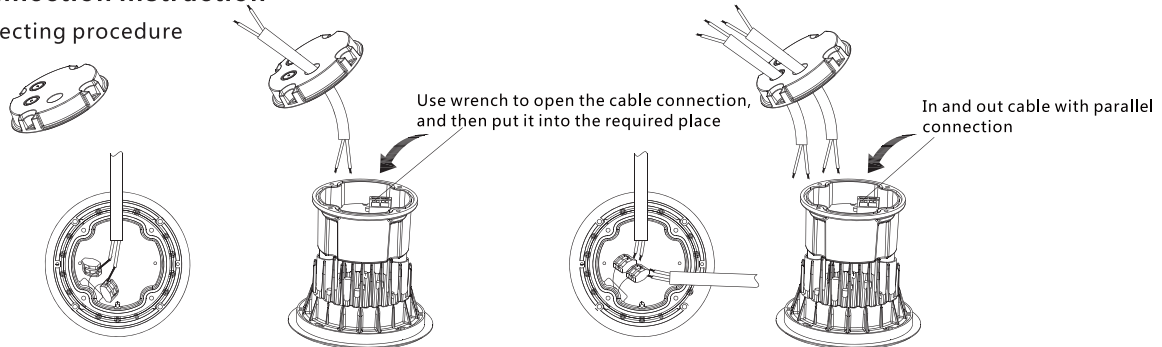

Gland size: D=8-10mm usage cable accepted H05RN-F 2G1.5mm<sup>2</sup>-2G2.5mm<sup>2</sup> SJTW 2×16AWG-2×14AWG

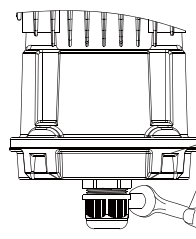
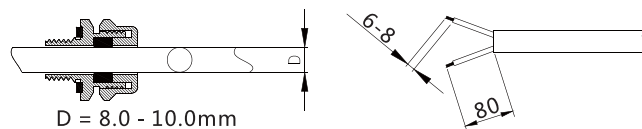

M4 screw hole distance Min=5 N·M  
M5 screw hole distance Min=6.5 N·M

Fasten by the wrench, the hole distance is Min=20 N·M

⚠ Remark: if the outer soft cable of the light broken, please change with the service agent, or the professional persons.