

LEGO Series (CE) (RoHS) (IP66)

LEGO series LED street light features with simple and fashion design, it is built under modern design concept which is reliable and energy-saving. with modern design and high efficiency LED driver technology LEGO provides excellent solutions for roadway illumination. LEGO LED street light not only meet large project's lighting requirement but also meet the concept of city sustainable development.





Product Dimensions:

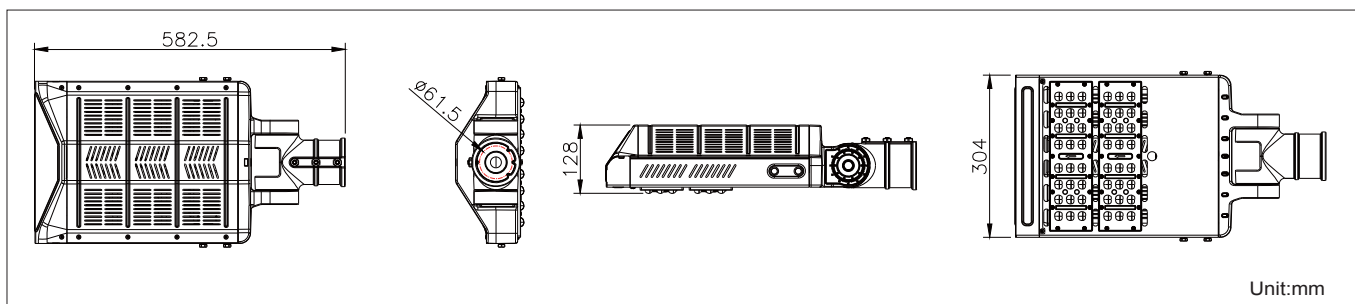

Luminous Intensity Distribution Diagram:

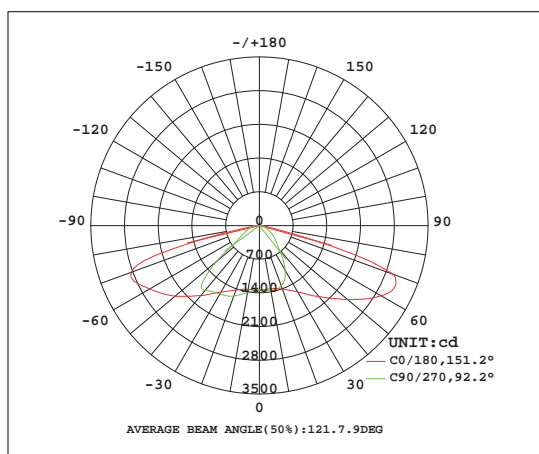

LuxDistribution:

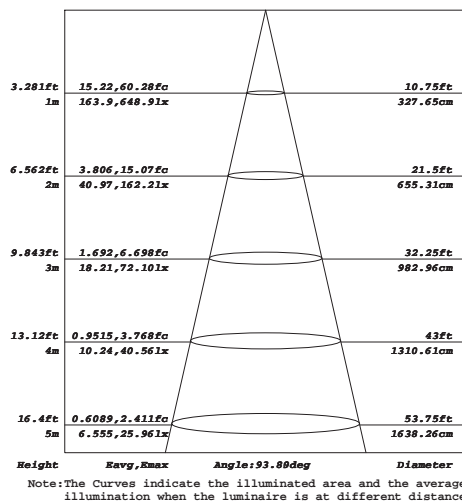

Manufacturing Quality Standard:

- ISO 9001:2008

LED Luminaire Standard:

- EN/IEC 60598-1
- EN/IEC 60598-2-1
- EN/IEC 60598-2-2
- EN/IEC 60529
- EN/IEC 62471-2
- IEC 62612
- EN/IEC 60968
- IEC 62560
- EN/IEC 60061-1
- EN 13032-1
- EN 13032-2
- EN/IEC 62471
- EN/IEC 60825
- EN 60061-1

LED Module Standard:

- IEC 62031
- IEC 60838-2-2

Electronic Driver Standard:

- EN/IEC 61347-1
- EN/IEC 61347-2-13
- EN/IEC 62384
- EN/IEC 61000-3-2
- EN/IEC 61000-3-3
- EN/IEC 61547
- EN 55015(CISPR 15)

RoHS Standard:

- EPA3050B
- EN 1122B
- IEC 62321
- EPA3052
- EPA3060A
- EPA7196A
- EPA3540C
- EPA8270D

LED Luminaire Performance:

- LM-80-08
- Switching cycle:100,000x

LED Light Photometric Standard:

- CIE; TM14; LM-75; IES; LDT; CEN; CIB

Features:

- Anode oxidized 6063 aluminum alloy and polycarbonate cover
- Protected against dust entry and water jets IP66
- Built-in IP66 class II Meanwell LED driver complied with UL, CSA, TUV and EMC standard
- High power factor (>0.9) and power efficiency design
- Adjustable Lamp pole Arm design easy to install and maintain
- The upward light ratio of luminaire less than 2%
- Optional: 10KV surge protection

Applications:

- Park Light
- Street Light



Specifications:

Power	50W / 60W / 70W
Qty of LEDs	112PCS (2x56)
Input Voltage	AC 200-240V 50/60Hz
Driver Efficiency	>90%
Power Factor	>0.95
Total Harmonic Distortion	<20%
Beam Angle	150°x90°
Color Rendering Index	>70
Luminaire Efficacy	135lm/W (2700K), 145lm/W (3000K), 150lm/W (4000K), 155lm/W (6500K)
LED Source Efficacy	150lm/W (2700K), 170lm/W (3000K), 175lm/W (4000K), 180lm/W (6500K)
Operating Temperature	-20°C~50°C
LED Source	CREE / LUMILEDS / NICHIA / OSRAM
Life Time	50,000 Hours
Operating Humidity	0~100%RH
Finishing Materials	Aluminum and Polycarbonate (Anti-UV)
IK Index	IK 08
Body Color	Silver Grey
RAL Color Code	RAL 7001
Net Weight	3871g

Ordering Part No.:

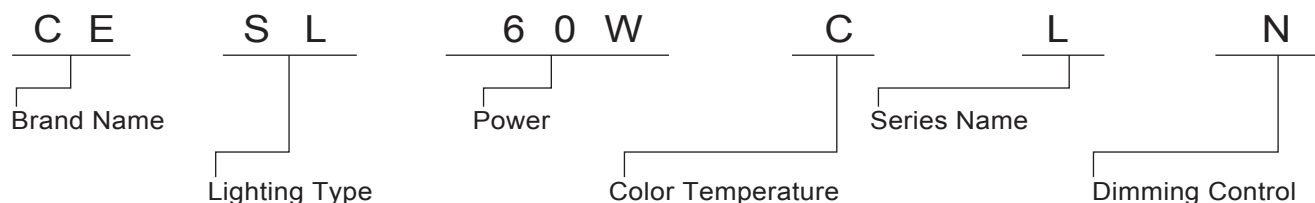

Brand Name	Lighting Type	Power	Color Temperature	Series Name	Dimming Control
CE: CELEX	SL: Street Light	50W 60W 70W	O: 2700K W: 3000K N: 4000K C: 6500K	L: LEGO Series	N: Switch In(ON/OFF) V: 0-10V Dimming D: DALI Dimming PP: Pre-Programme Time Control

Structure Detail:

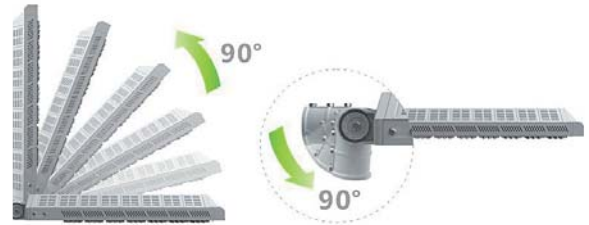
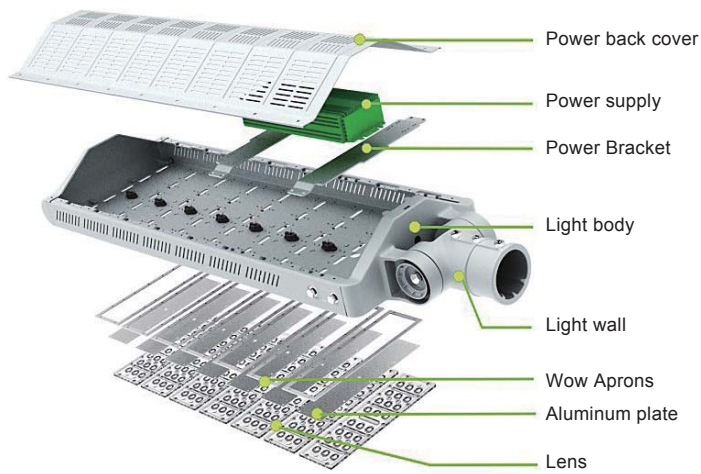

Light-up and 90 °

Down and 90 °

Accessories:

1. Lamp Pole Arm $\Phi 60\text{mm}$

P/N: CEGOAMR-60

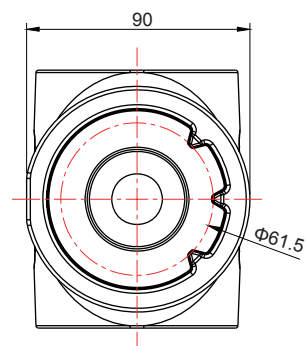
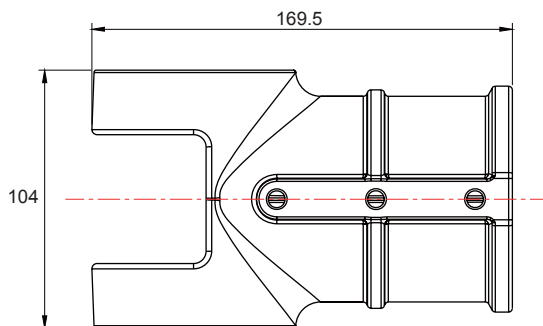

2. Lamp Pole Arm $\Phi 70\text{mm}$

P/N: CEGOAMR-70

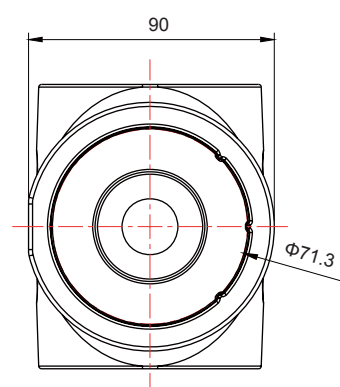
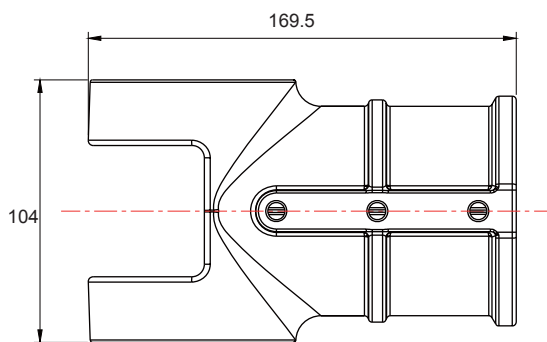

Unit: mm